

MOOD BOARD IMAGE OF ARTIFACTS BRANDING

CMYK

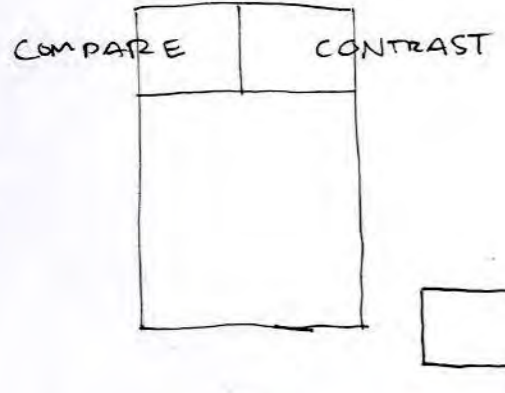
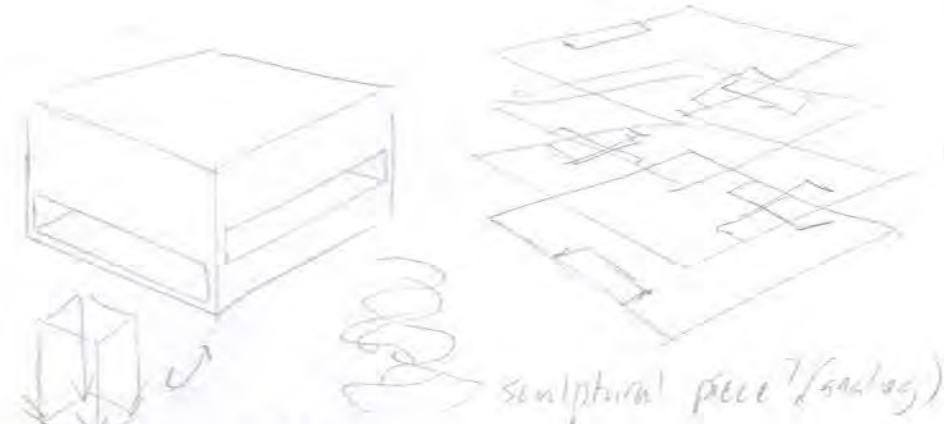
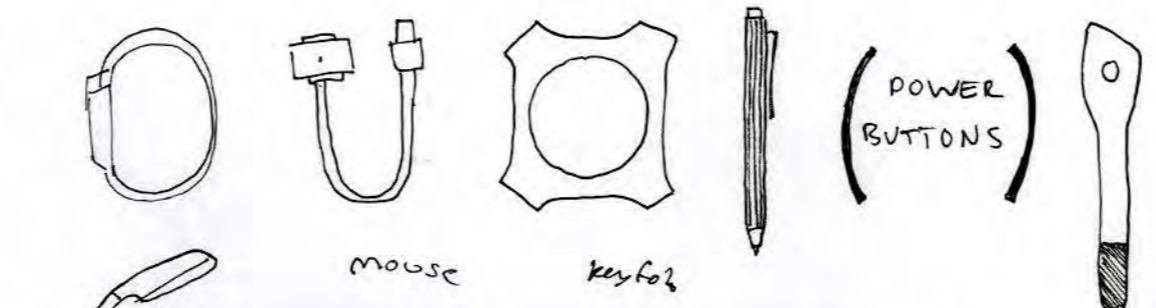

C/C: FAMILY ON PHONES
VERSUS SOCIALIZING

HOLDING HANDS
(CONNECTING)

FACES CLOSE TOGETHER

OCEAN PICNIC
SITTING ON GRASS

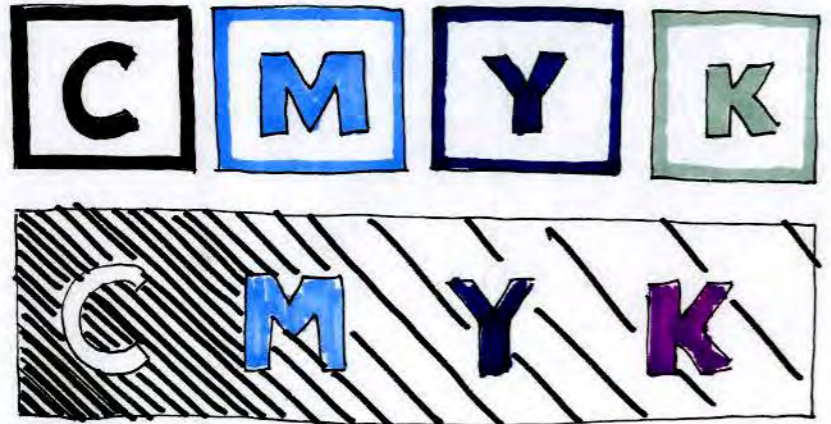
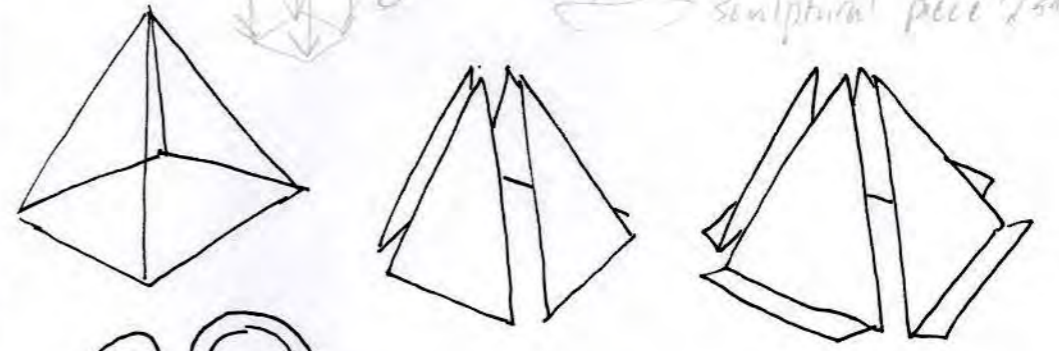
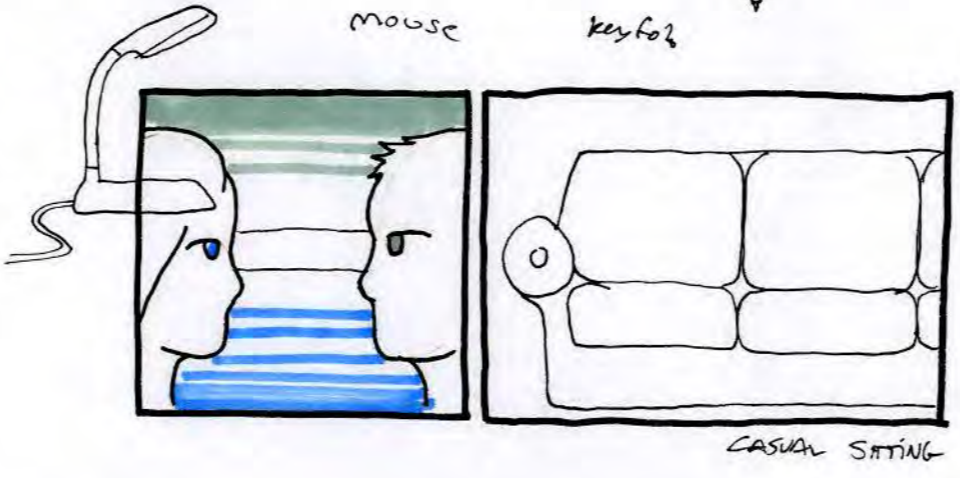

CLOSE UP OF A CLARINET DISCS

layering cards based on importance

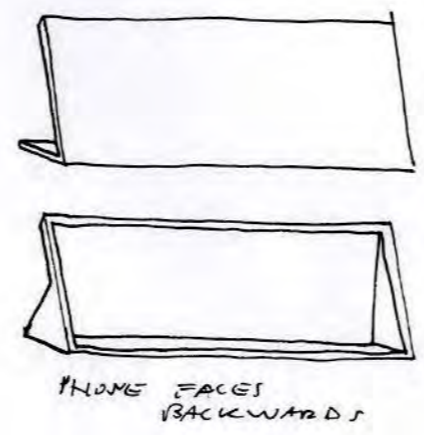

Tell A STORY

DUTCH → RESTAURANT → FRIENDS → SOCIALIZING

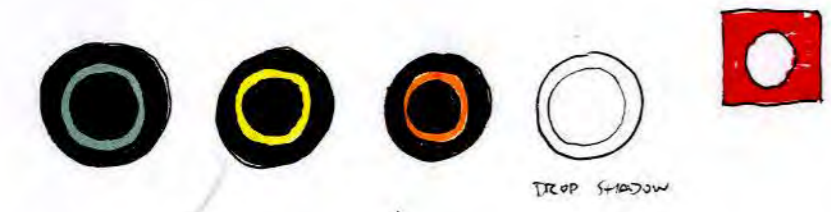
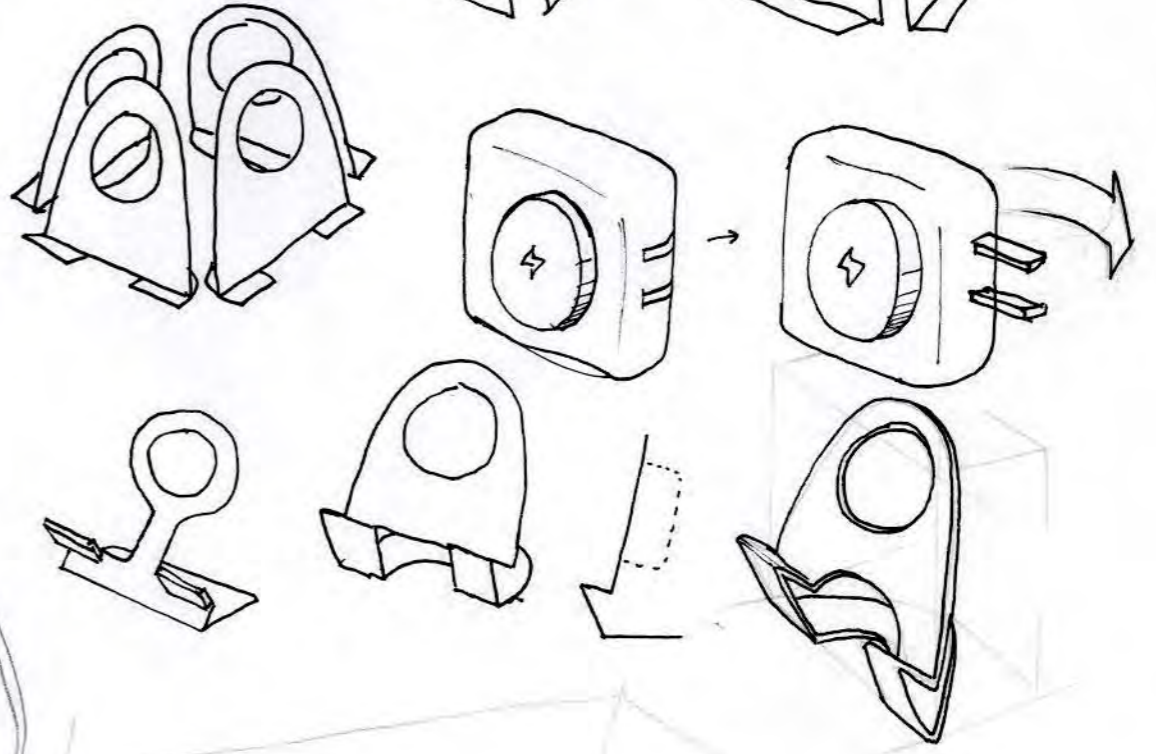

- * Napkin + wet wipes
- * Silverware
- * Salt / pepper
- * Sugar
- * Condiments
- * straws?
- * WI-FI PASSWORD

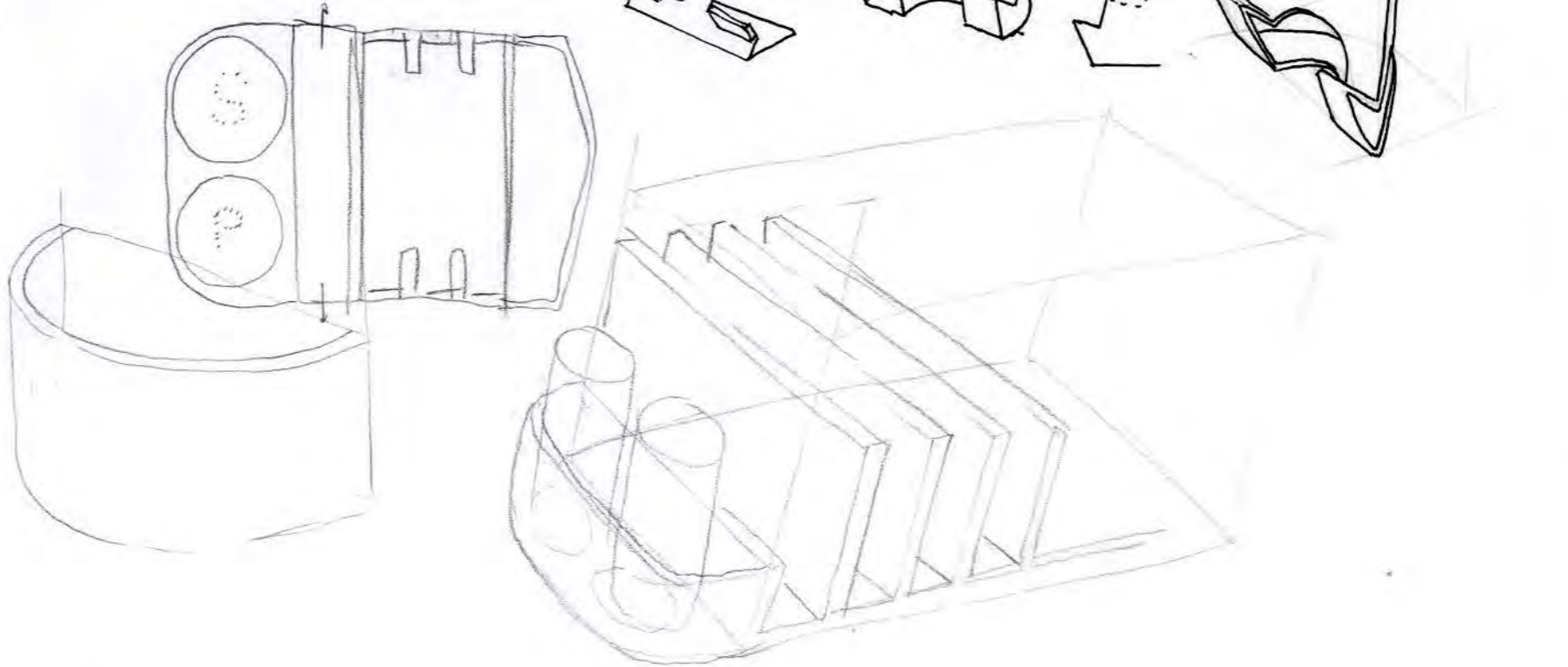
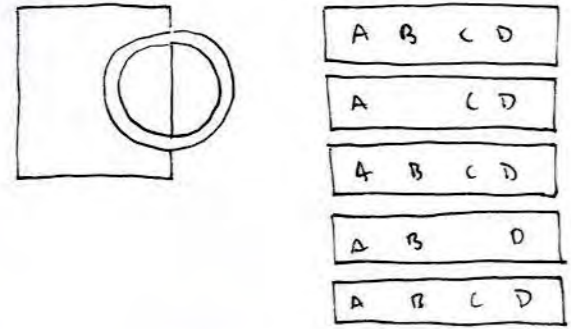
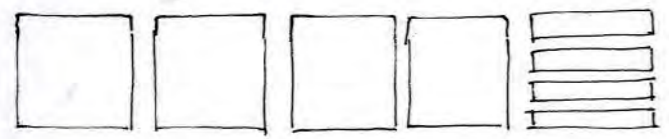

GOAL INTERFERENCE

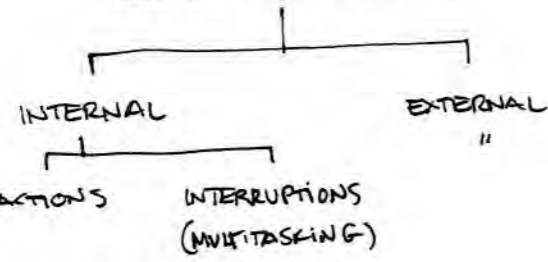

GOAL: HEALTHY SOCIALIZING
 STIMULATED CONVERSATION
 - LACK OF AWKWARD PAUSES
 - NEW ENGAGING TOPICS

EXTERNAL → CELL PHONE ATTACKING SENSES
 INTERNAL → NEED TO CHECK NOTIFICATIONS/DEVICE

□ SINGLE-TASKING

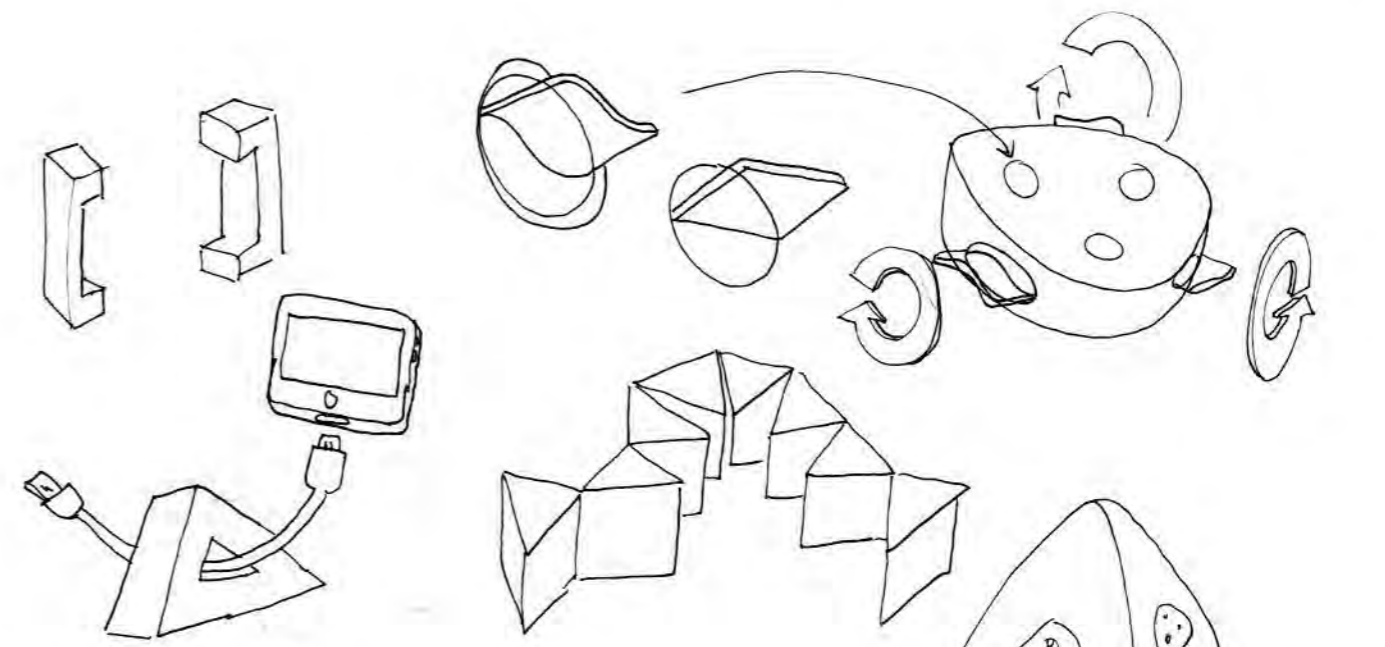
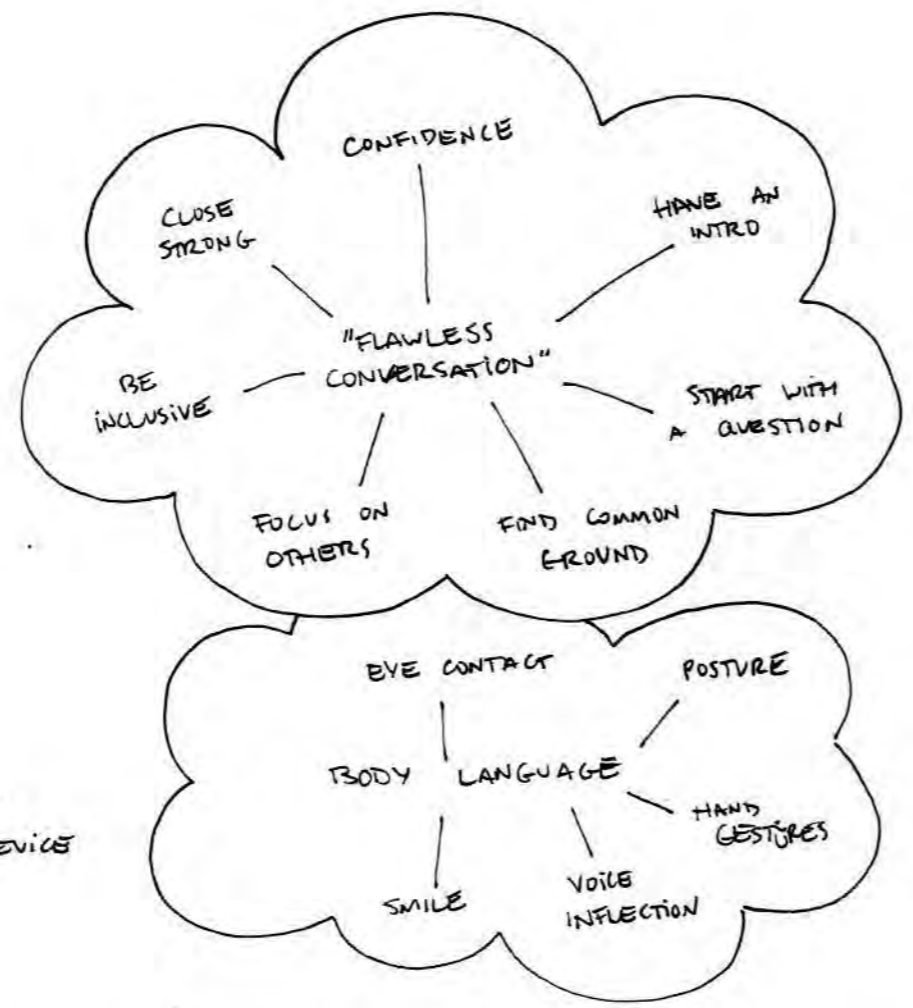

Completing the puzzle conceals the plug

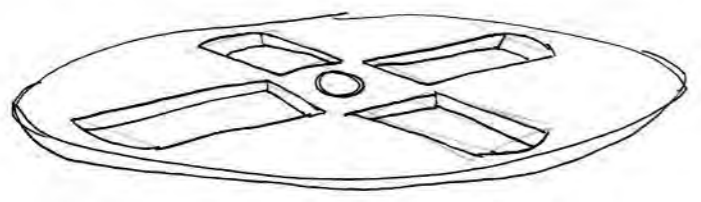
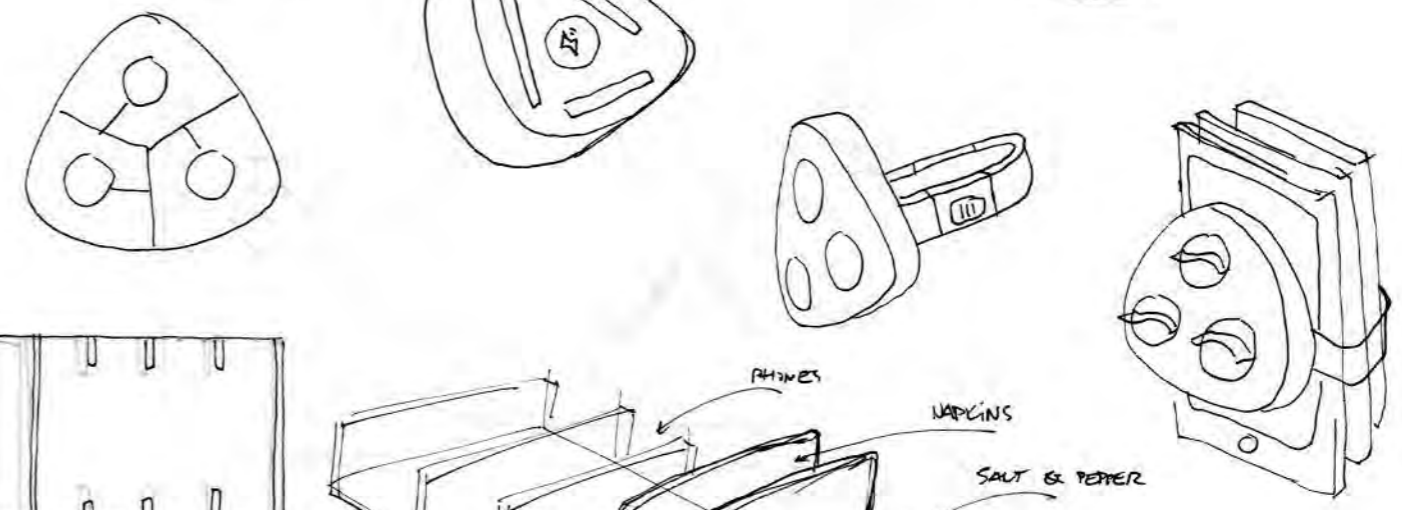

WORZLY TABLE
 WORZLY PLATE

FUN

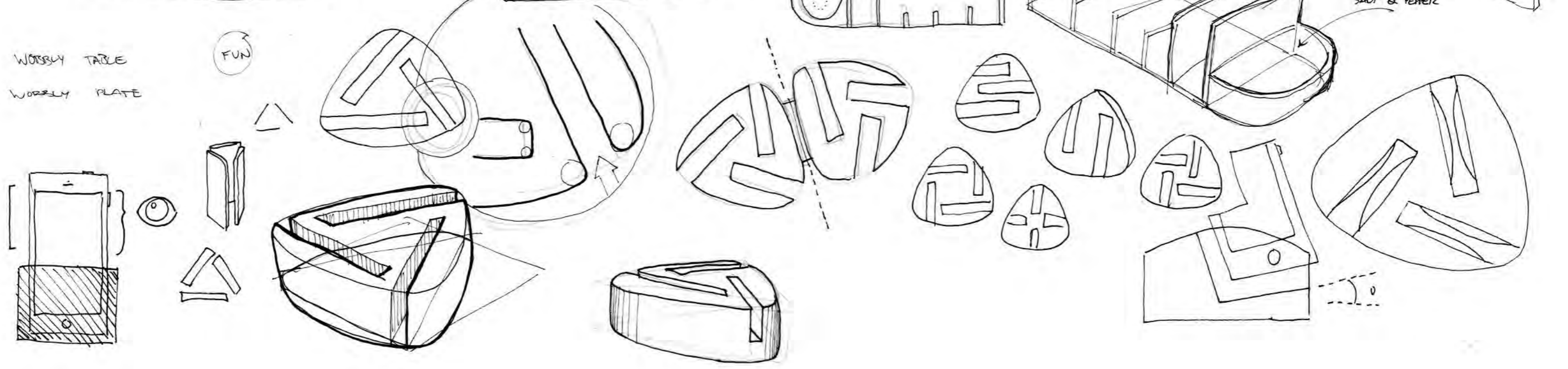

PHONES
 NAPKINS
 SALT & PEPPER

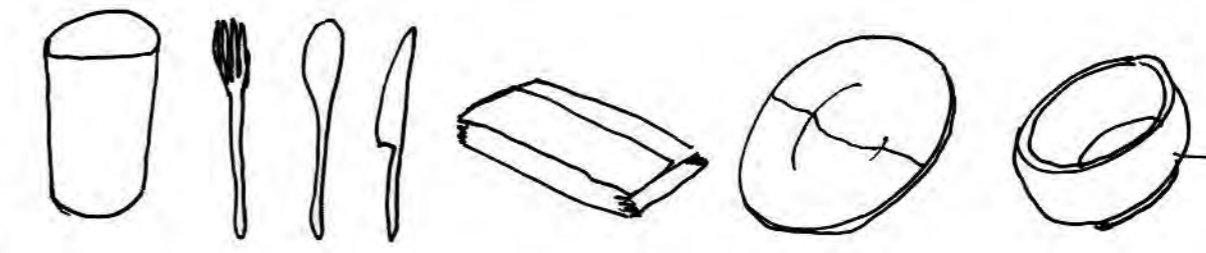
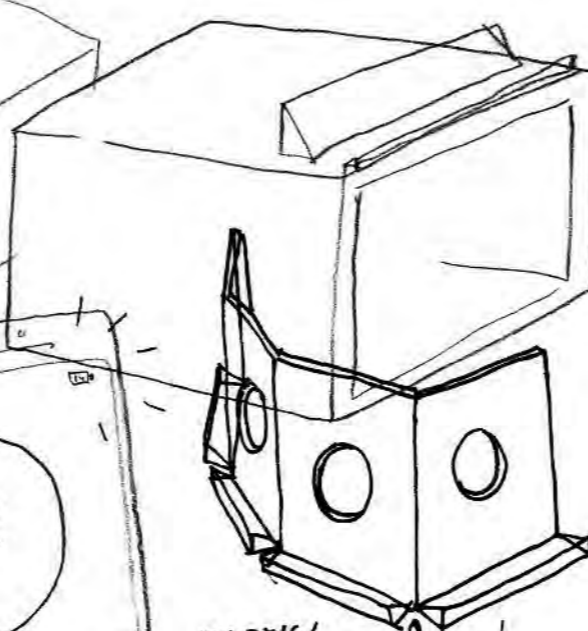
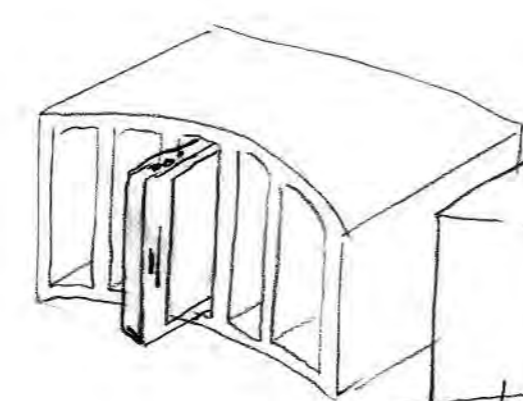
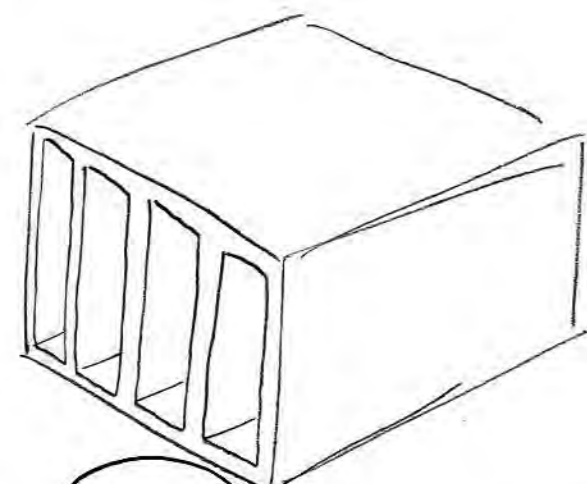

ALREADY ON SURFACES / TABLES

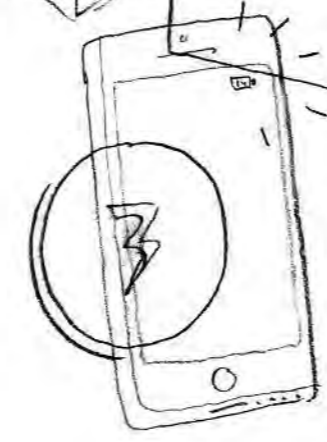
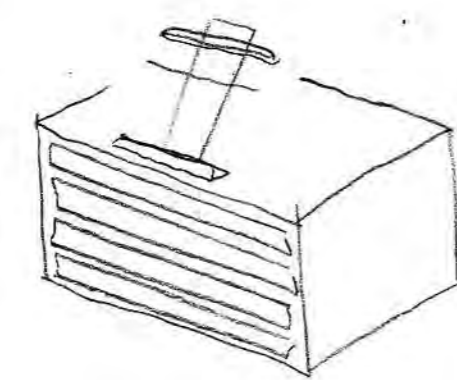
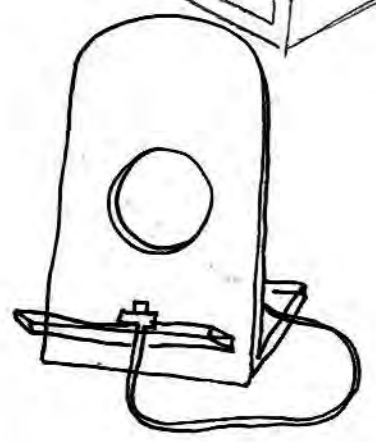

FOLDING/ROTATING

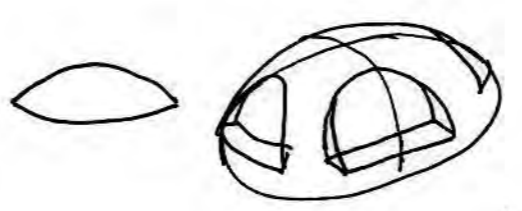

CUC

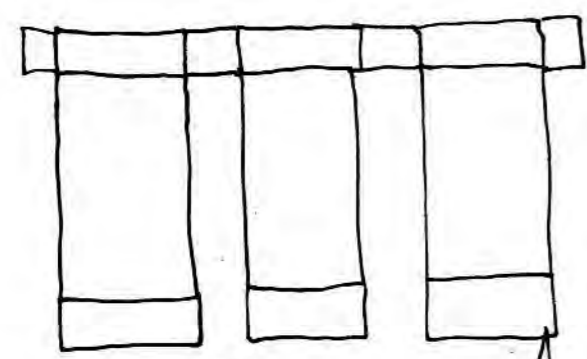
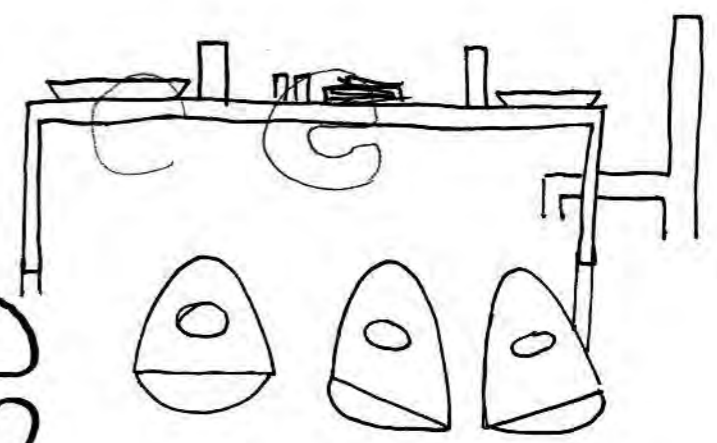

APPLE'S MAGNETIC CASE MATERIAL?

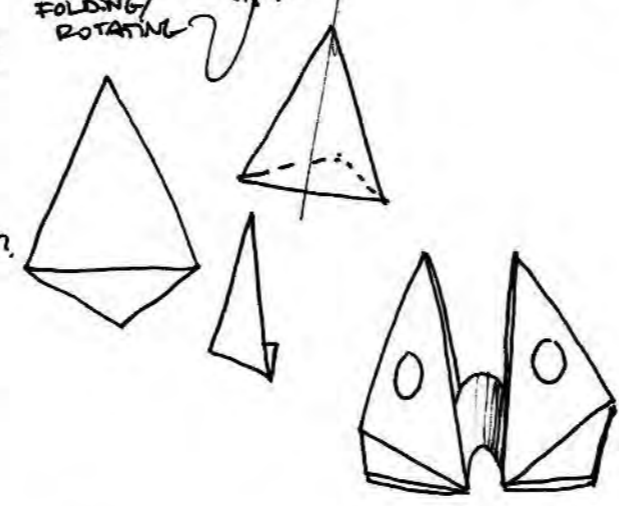
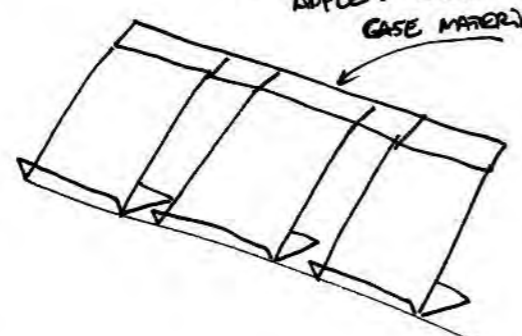

FOLDING LINES

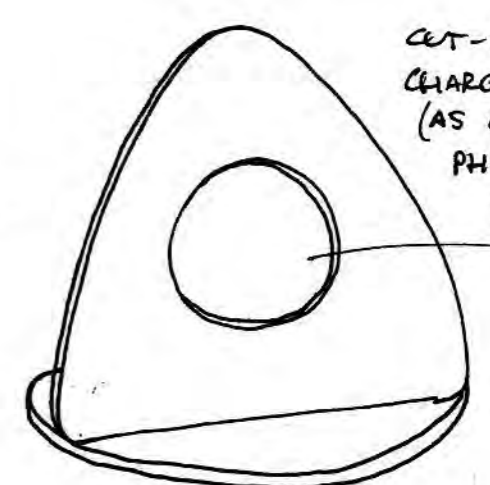
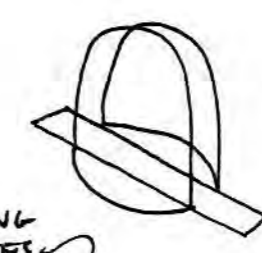

CUT-OUT FOR CHARGING BATTERY (AS CLOSE TO PHONE AS POSSIBLE)

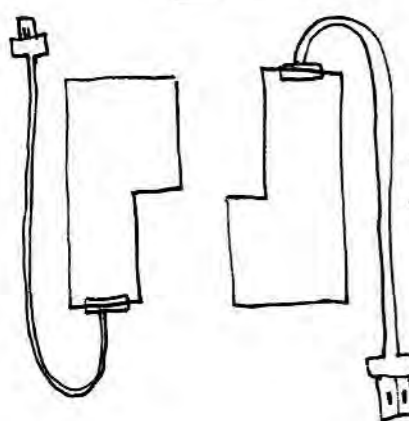

JENGA? PUZZLE GAME

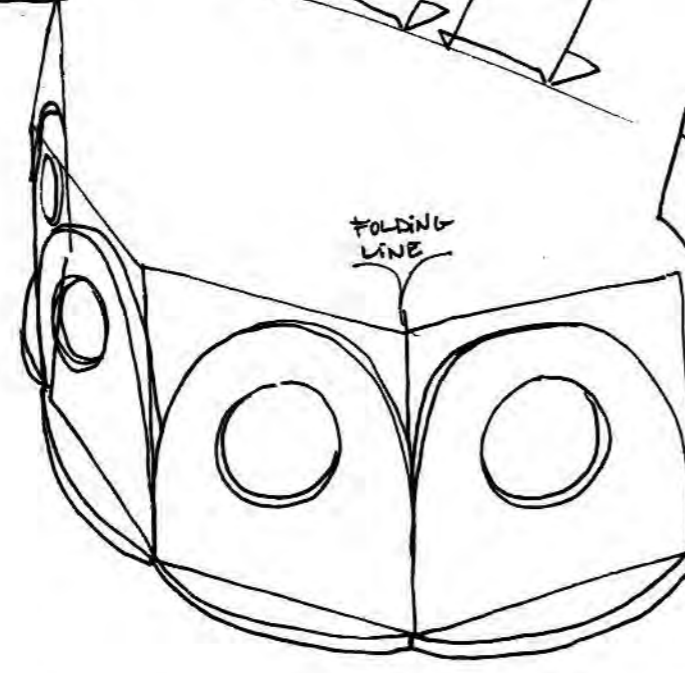
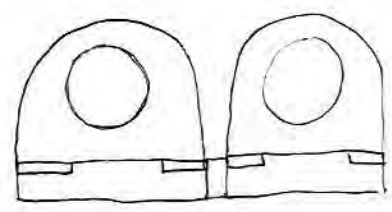

FOLDING LINE

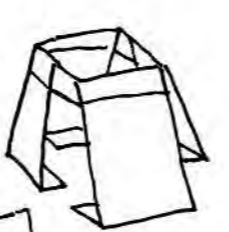

INDIVIDUAL MODE
GROUP MODE

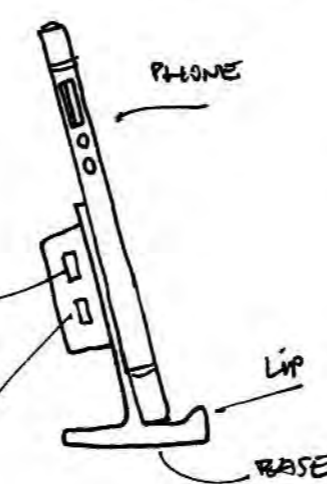

PHONE

LIP

BASE

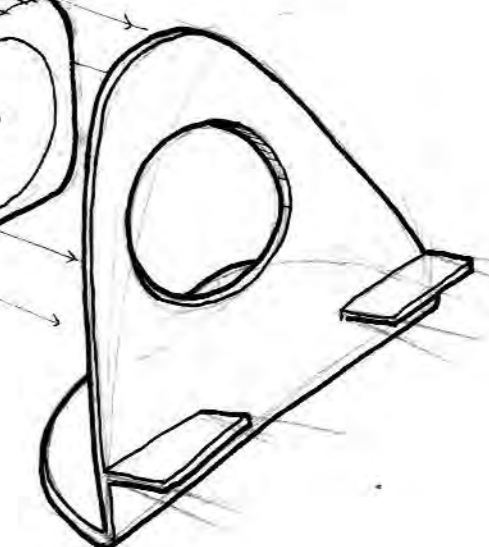
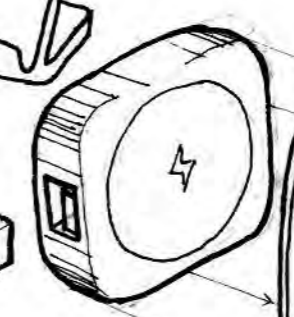
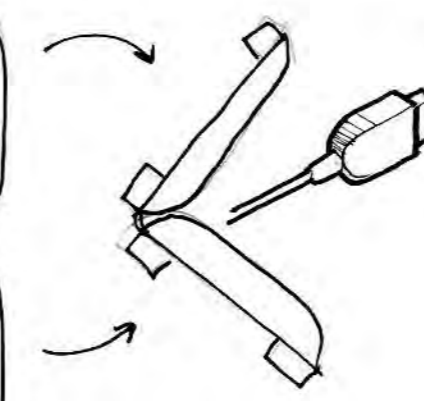

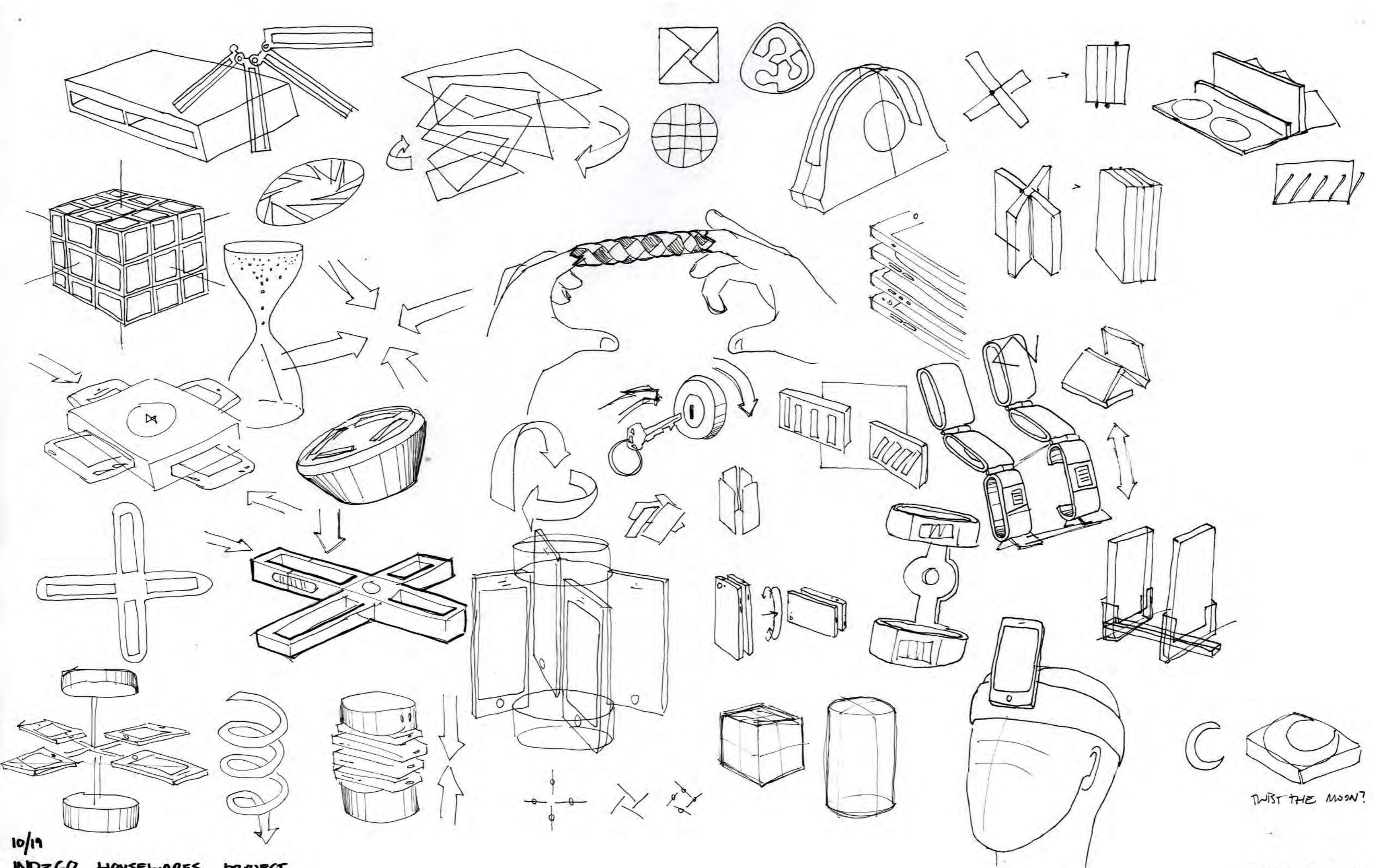

10/19
IND360 HOUSEWARES PROJECT

TWIST THE MOON?

NICHOLAS CYR

makes noise

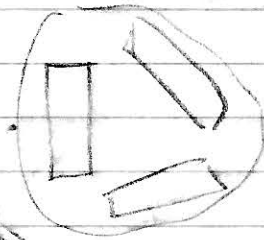
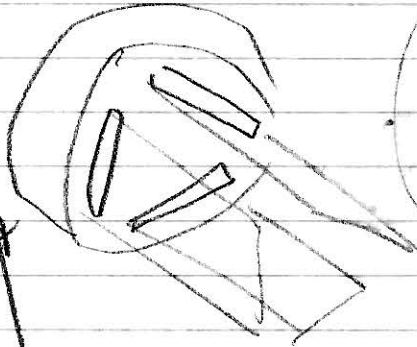
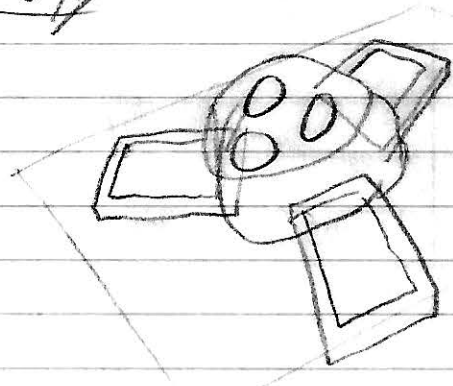
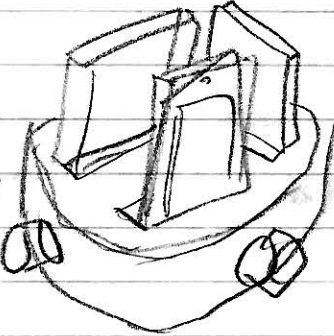
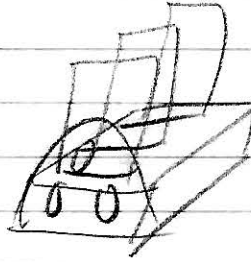
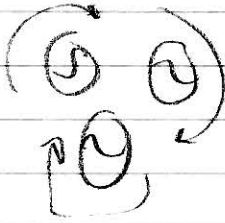
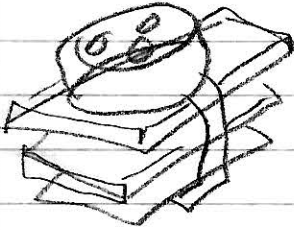
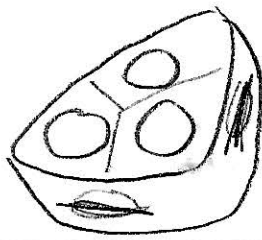
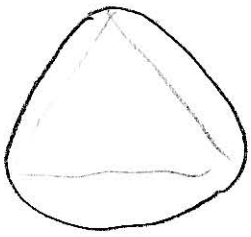

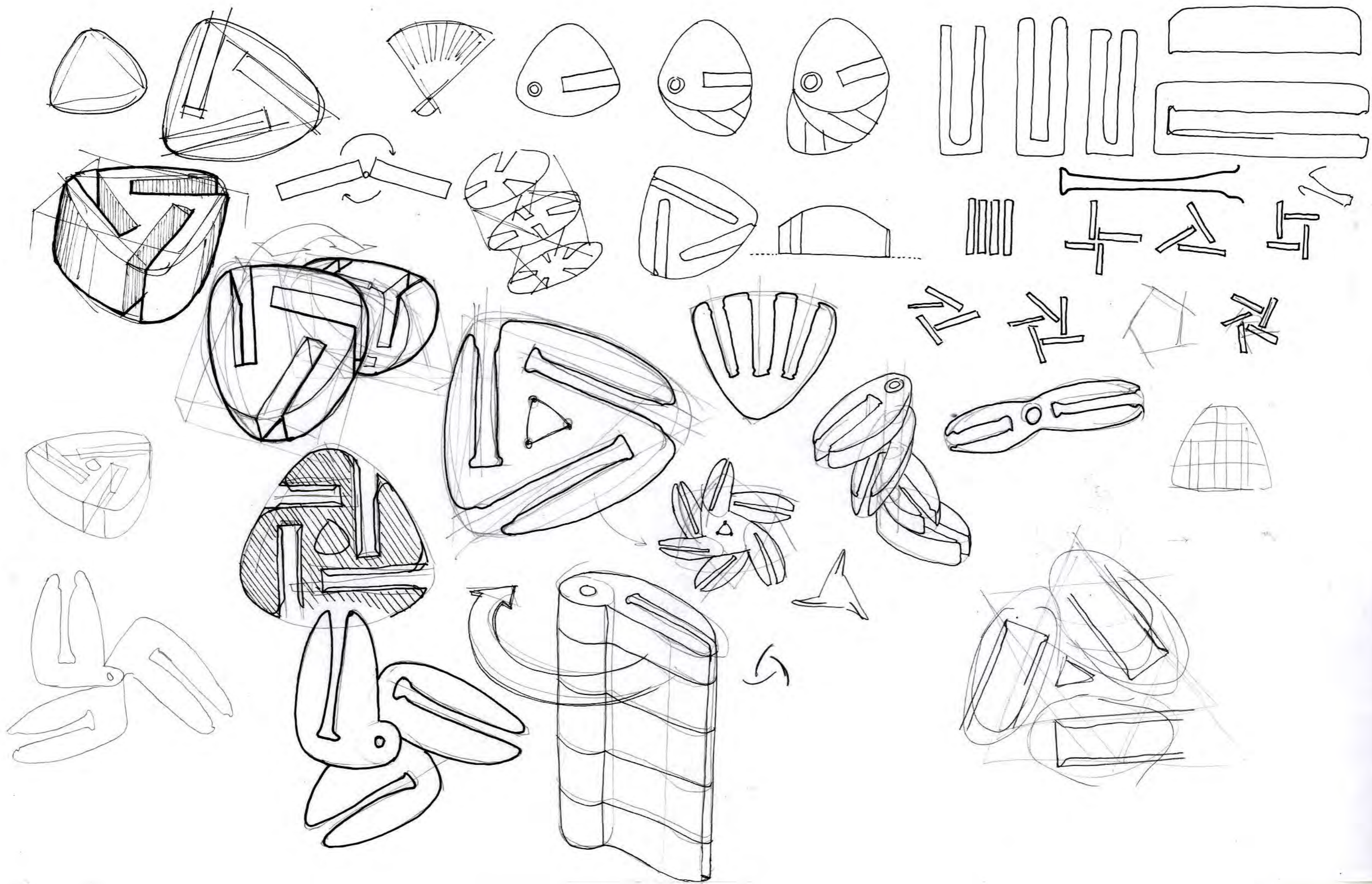

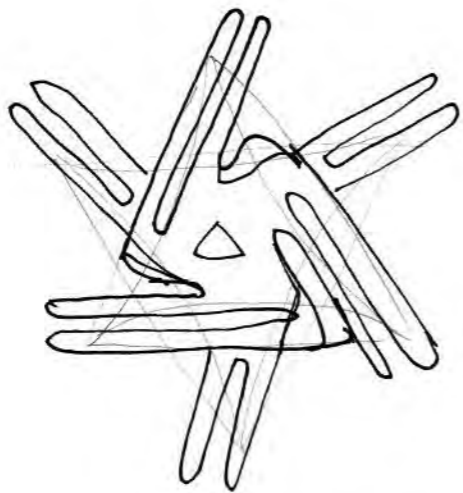
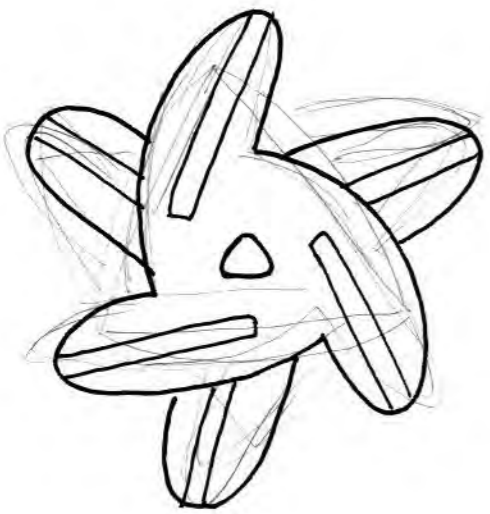

EXTRA SLOTS FOLD OUTWARD
ROTATE

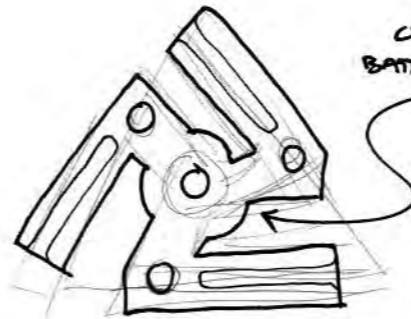
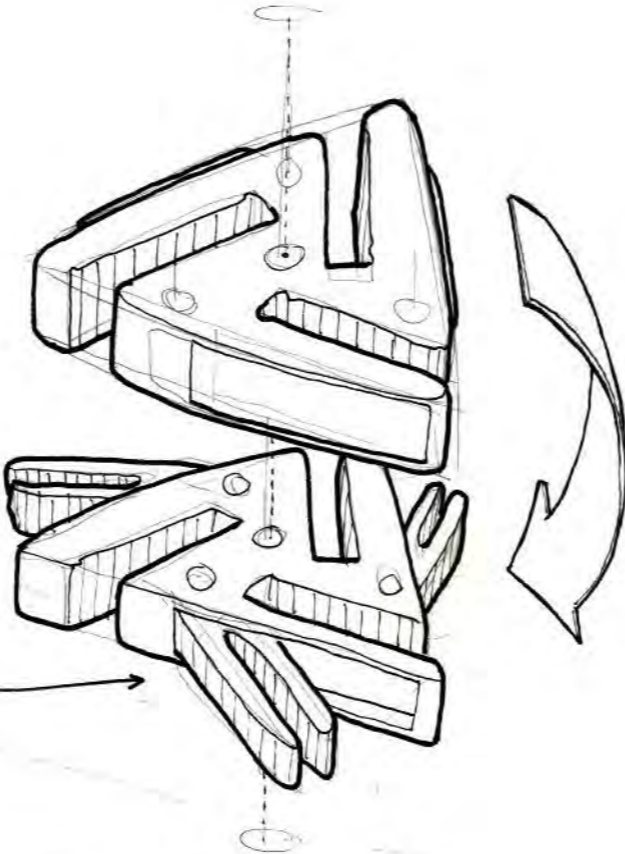

CENTRAL
BATTERY PACK

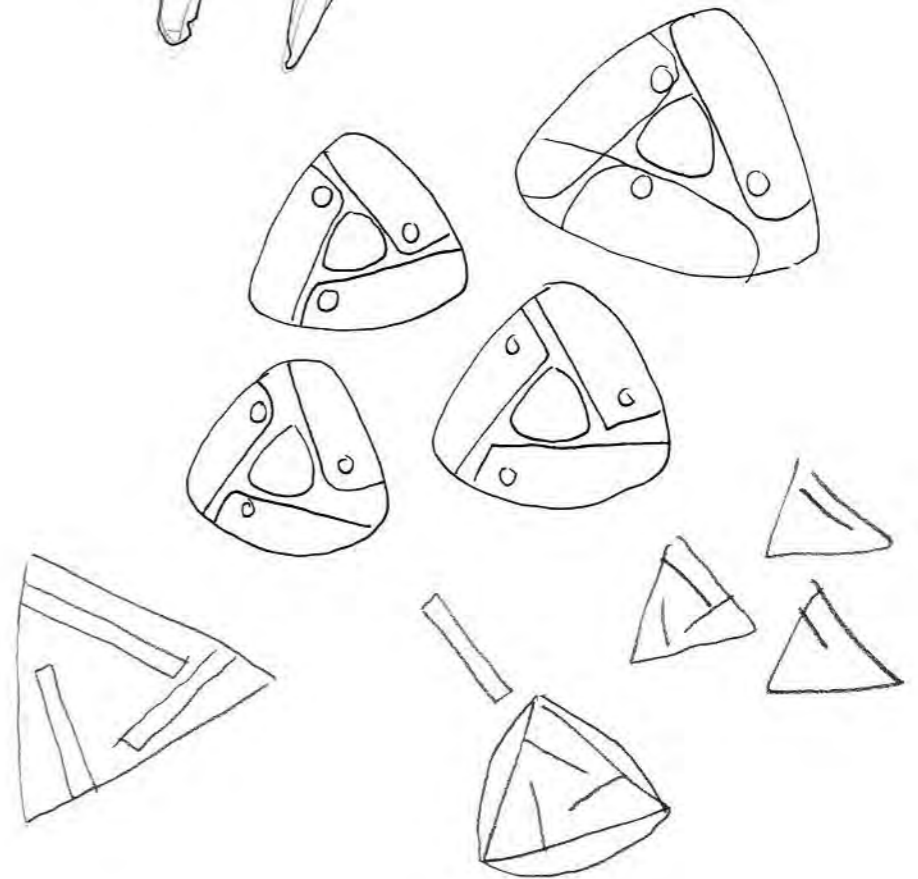
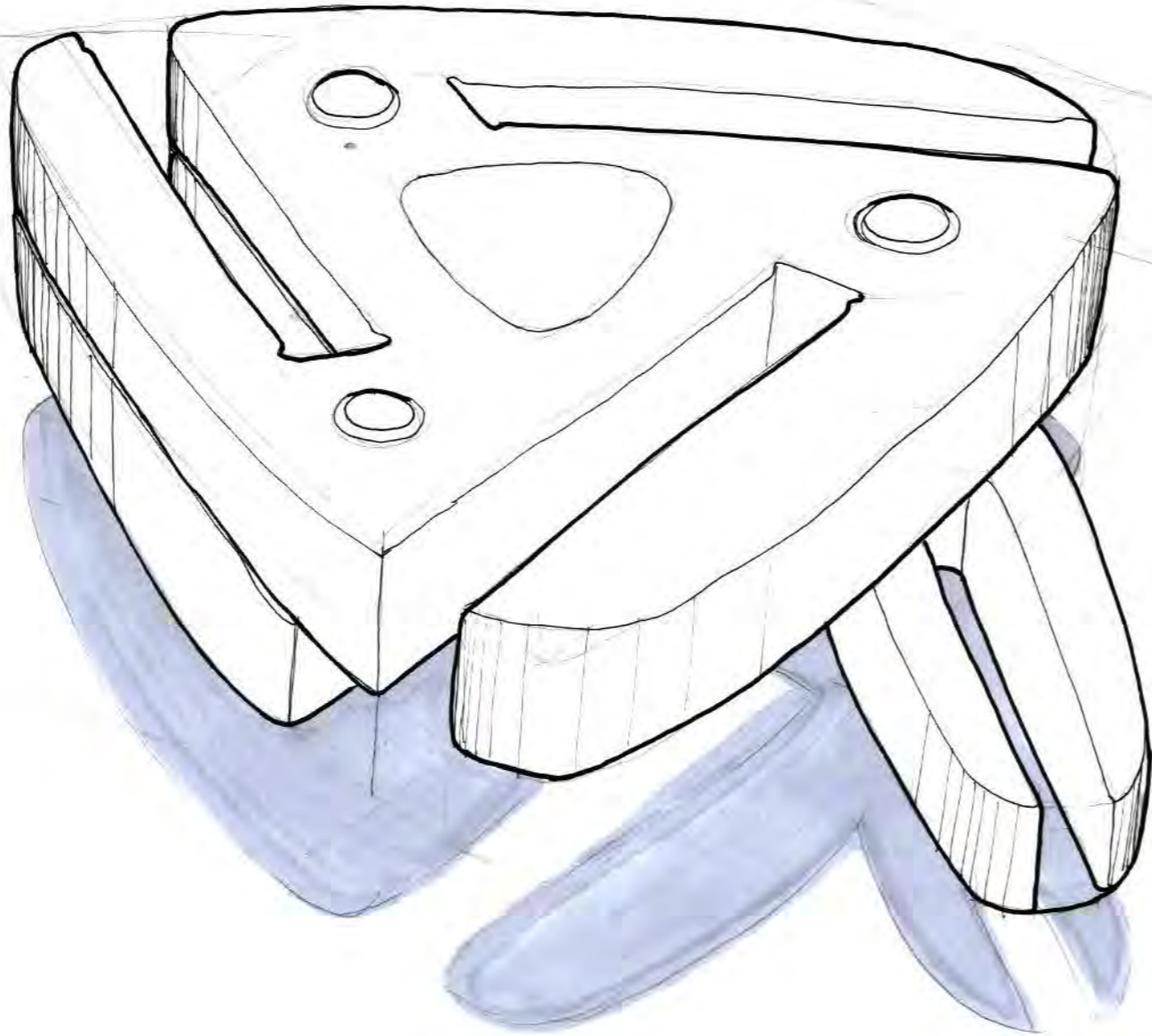
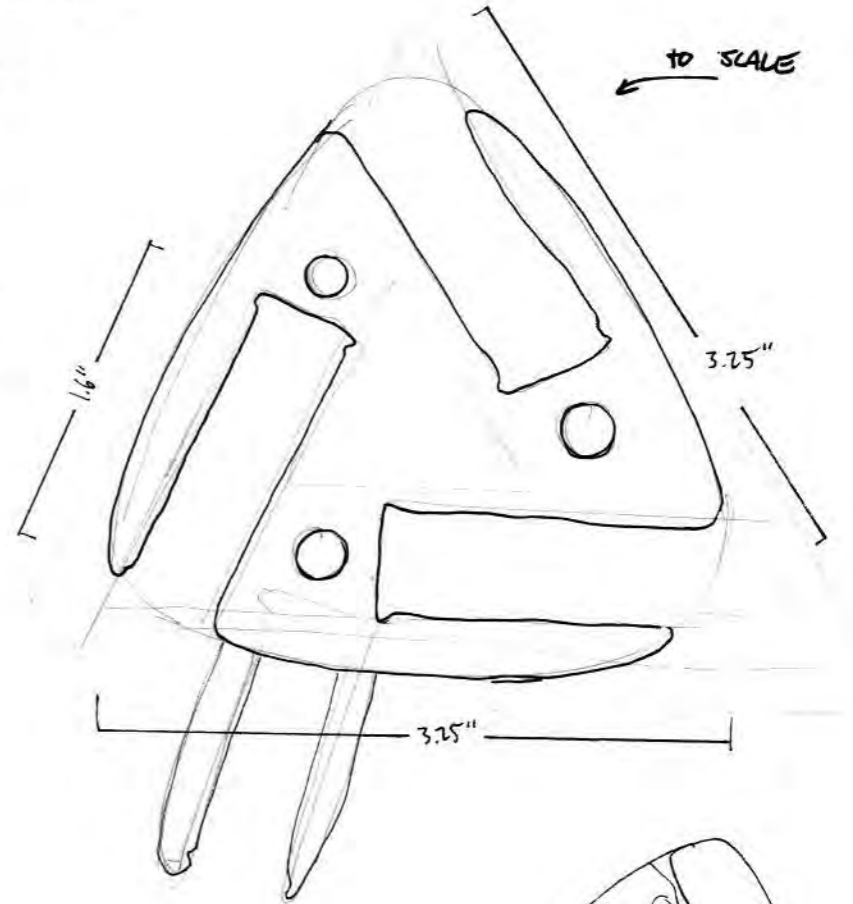
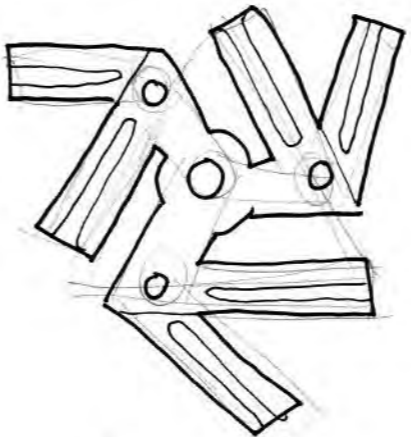

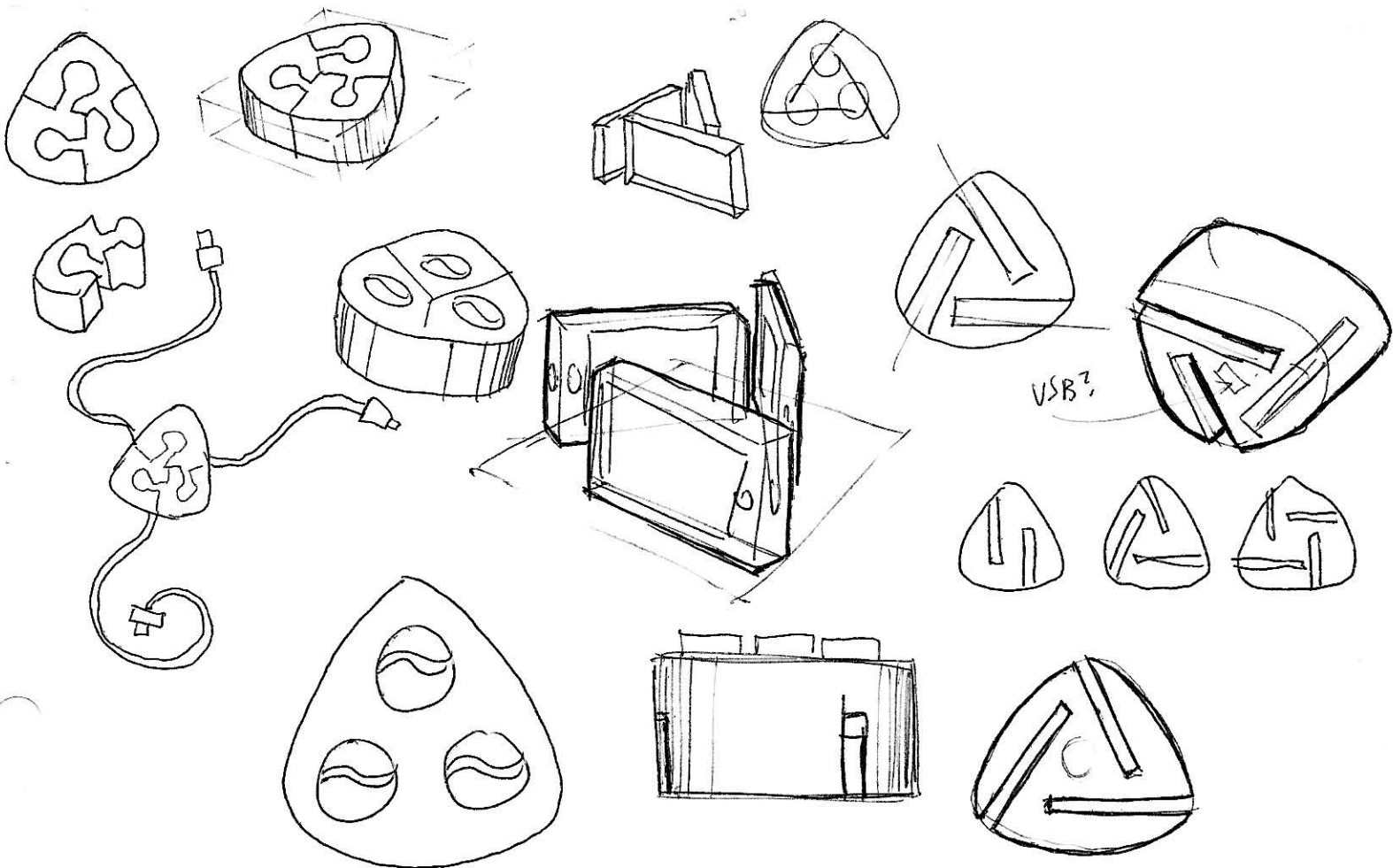
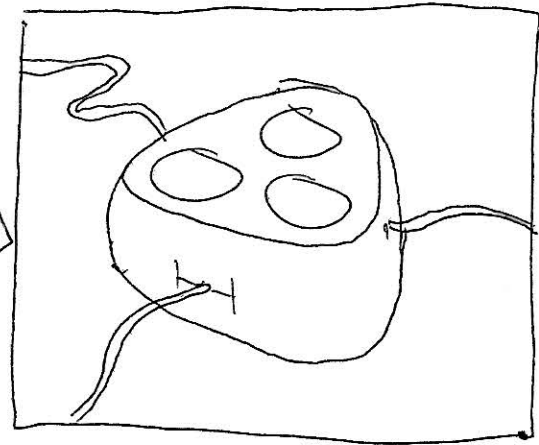
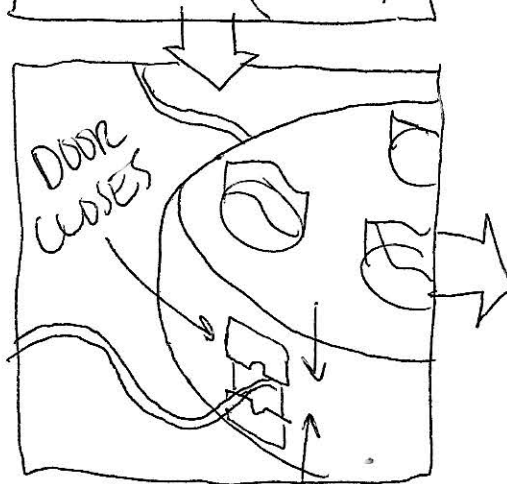
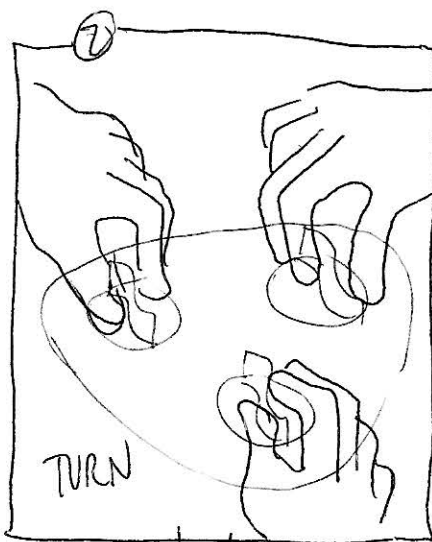
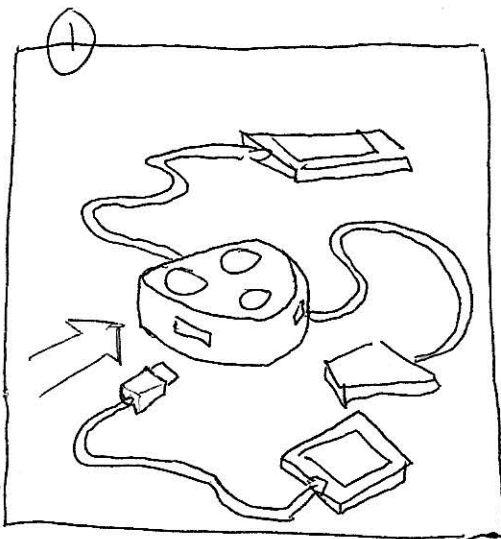

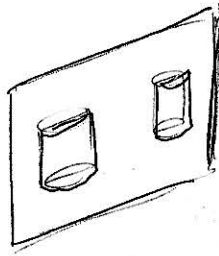
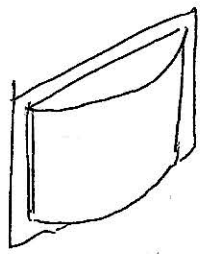
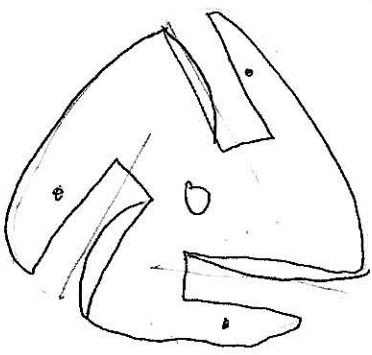

BATTERY

~~GOLD COATED~~
NANO WIRE

• CHARGE PORT

• WIDTH ADJUSTMENT gold nanowire coated
in manganese dioxide shell
• LIGHT

• ON/OFF BUTTON

with electrolyte encasing

(200,000, no loss of capacity)

(current cap 7,000)

+500 years

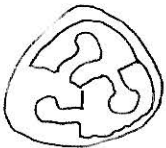
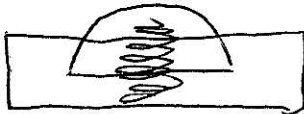
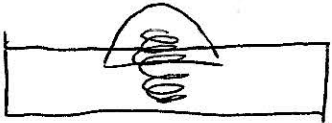
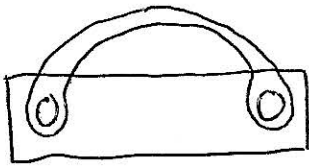
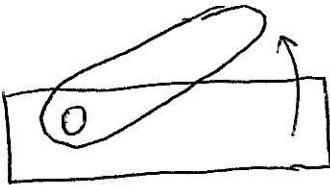
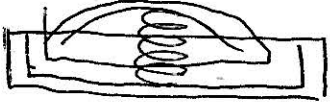
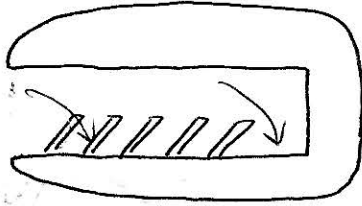

CUE

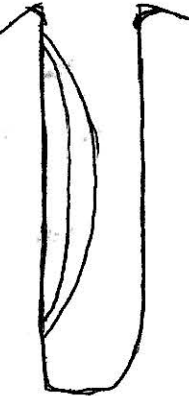
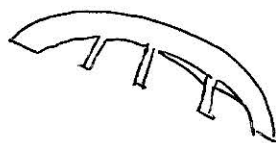
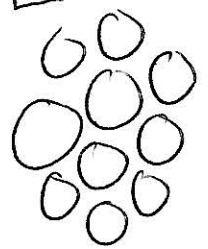
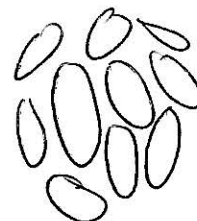
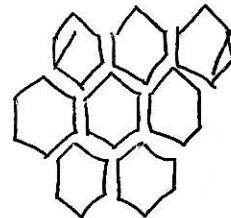
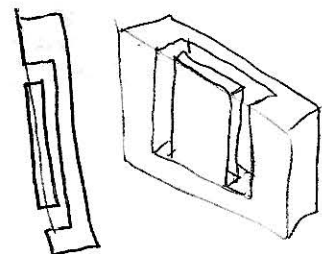
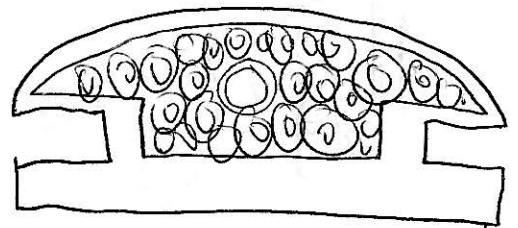
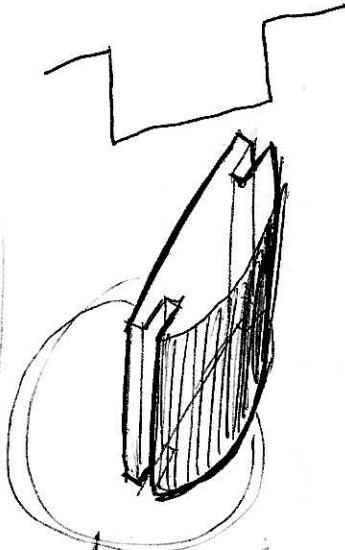
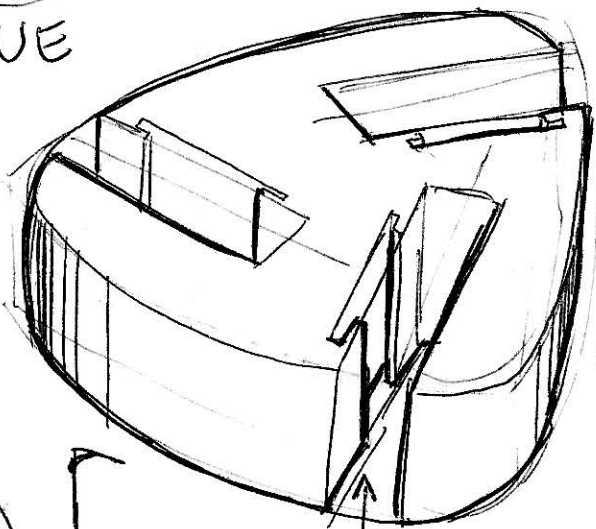

CUE



POWERFULLY SOCIAL

SOCIAL, HANDS FREE.

HANDS FREE SOCIAL

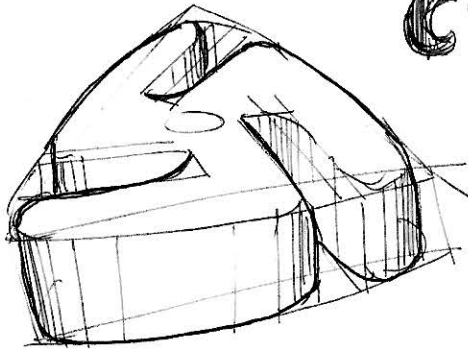

- IMPROVE THE STANDARD OF TIME SPENT W/ FRIENDS
- BRING CONVERSATION BALL TO YOUR SOCIAL CIRCLES
- BRING LIFE BALL INTO GROUP HANG-OUTS
- LIGHTEN UP
- DISTRACTION
- TABLE MANNERS

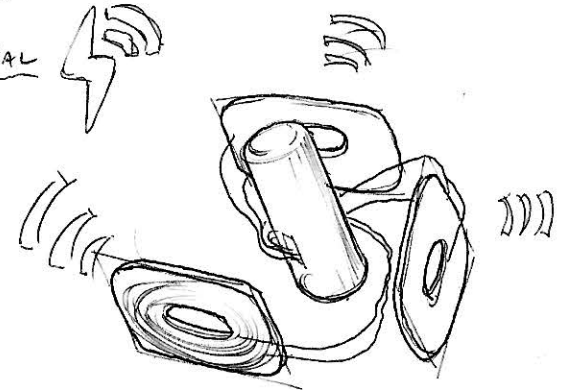
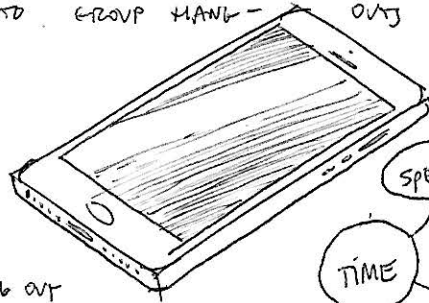

INDUSTRIAL DESIGN

PHONE BUMPERS

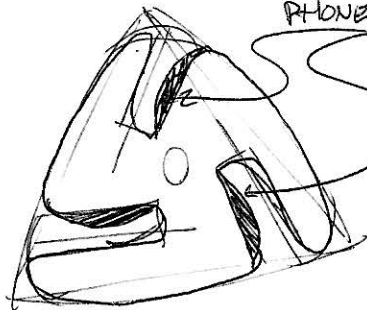

- SUPERCHARGE YOUR HANG OUT

TAKES CHARGE OF HOW YOU SOCIALIZE

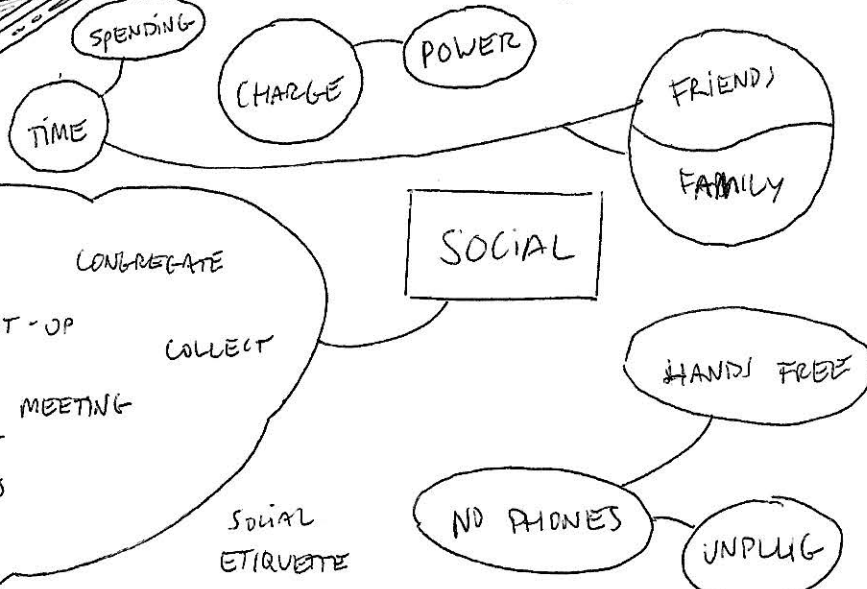
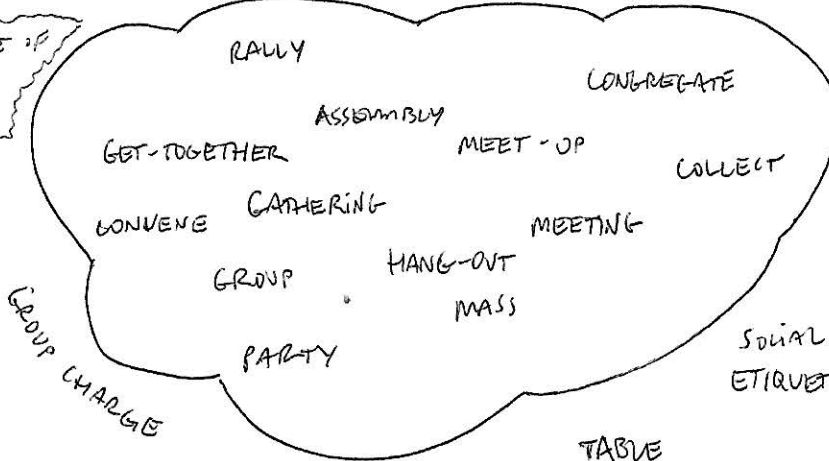

ELLIPSE

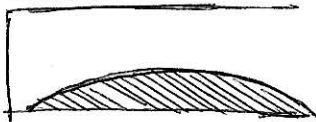

SQUARE/CIRCLE - SQUARE



2 CIRCLES

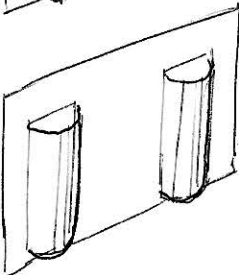
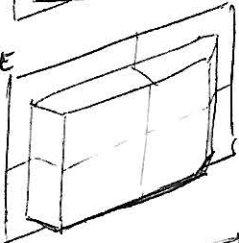
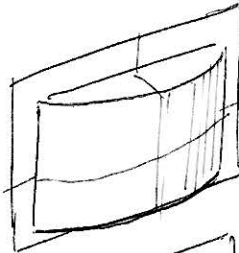

- * CHARGE
- * POWER
- STIMULATE
- ELECTRIFY
- FUEL
- REVIVE
- SPARK

TABLE
TABLE-TOP

SURFACE

STANDS OUT
STANDING
STAND UP

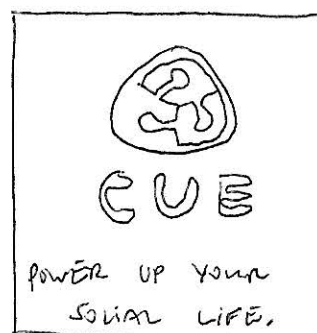
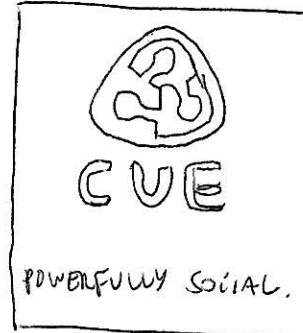

POWER UP YOUR SOCIAL LIFE

CUE

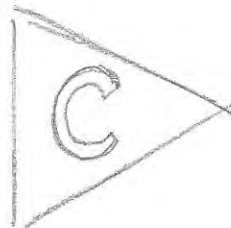
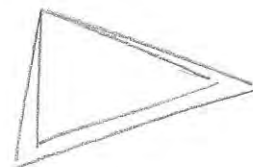
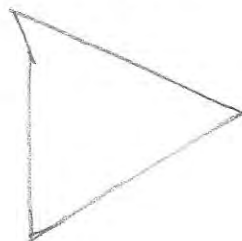
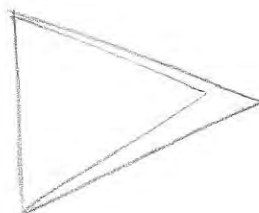
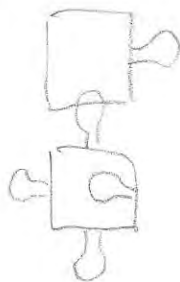
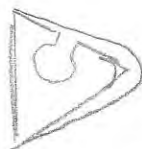
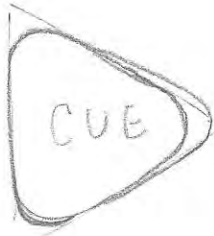
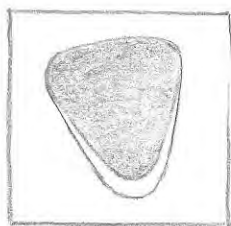
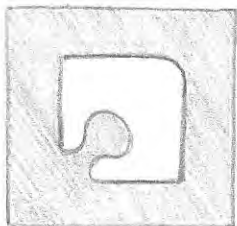
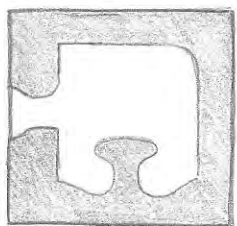

cue

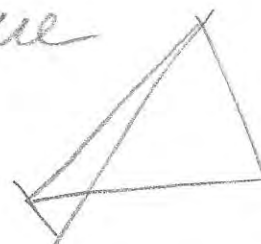

Social

Q

cue

queene

q

q

Q

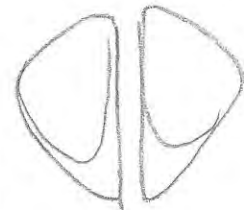

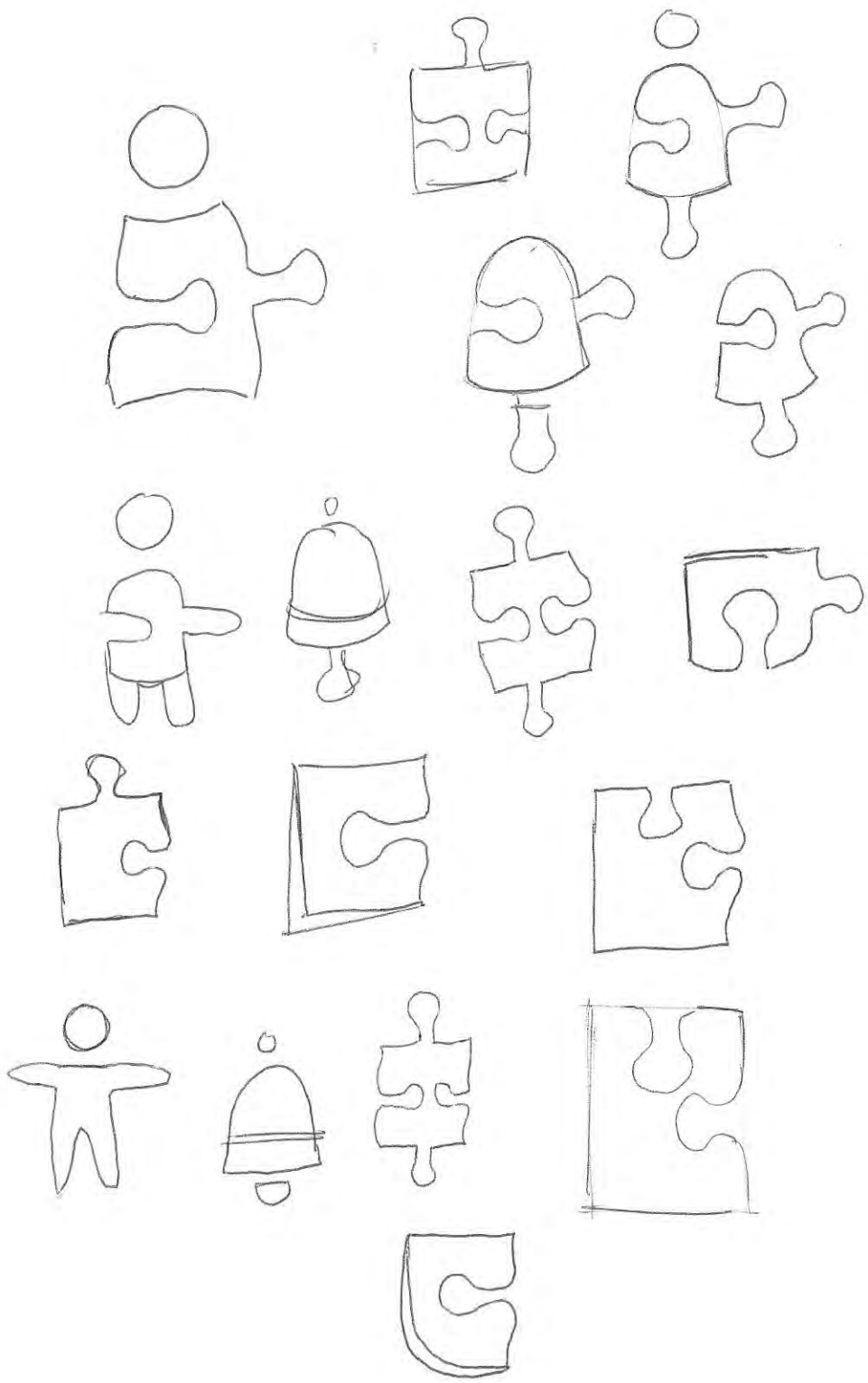
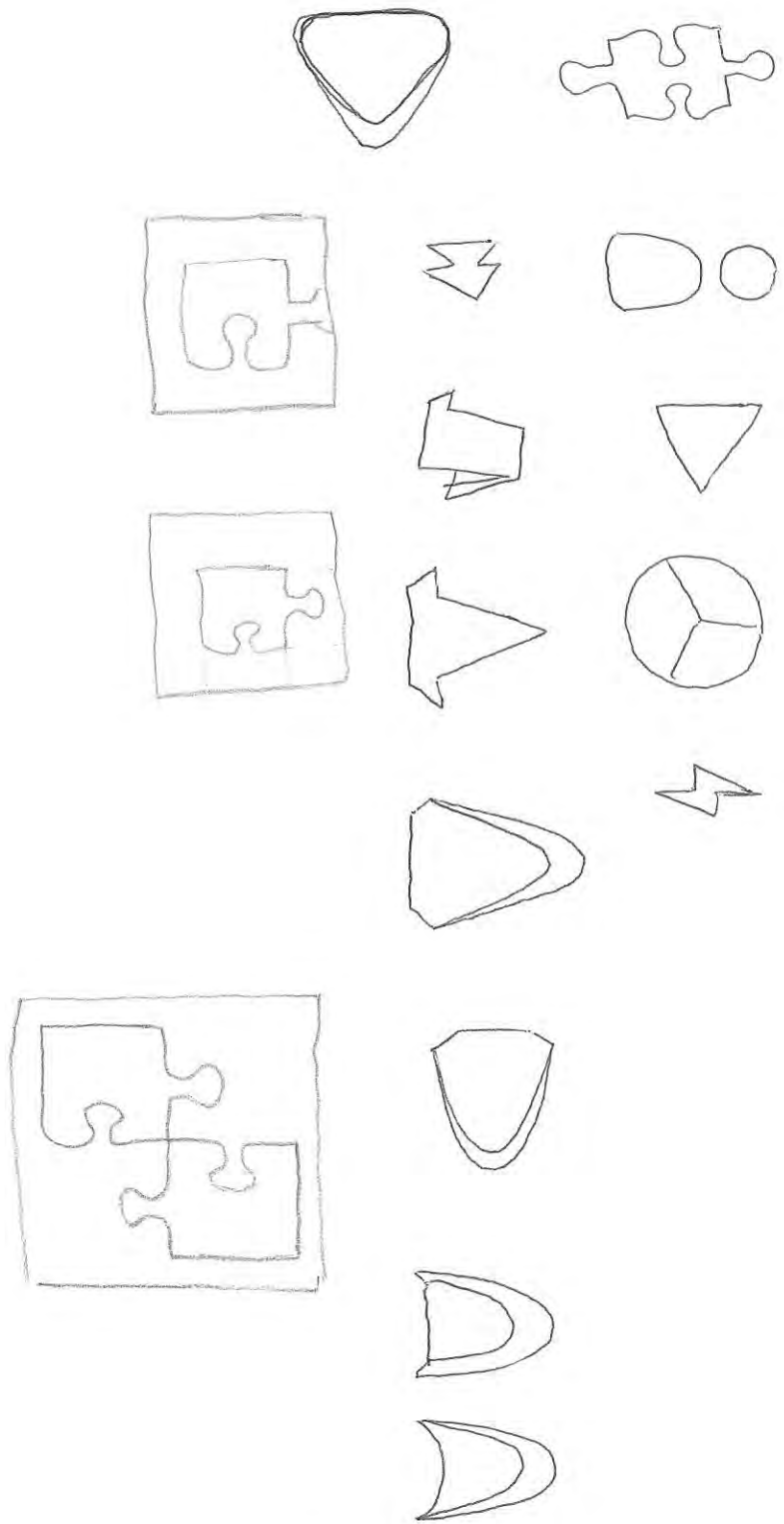

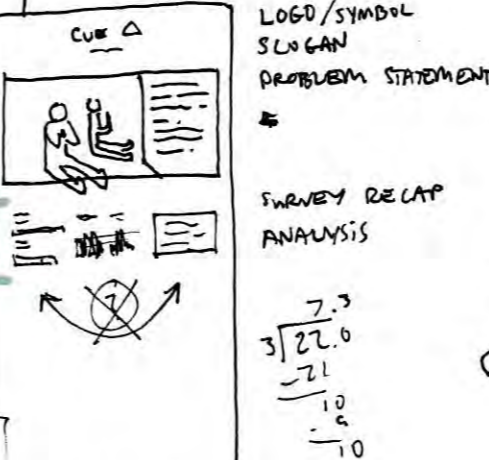
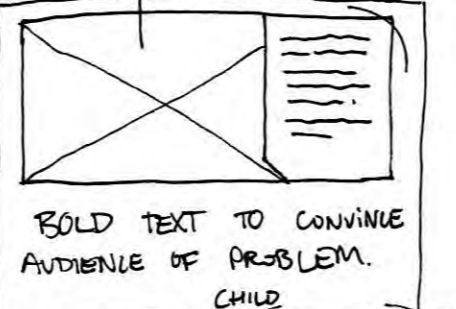
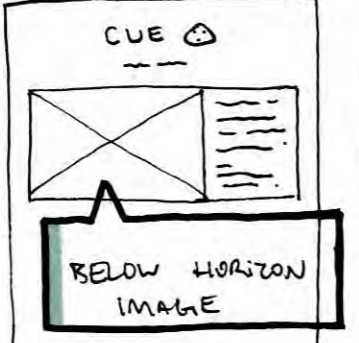
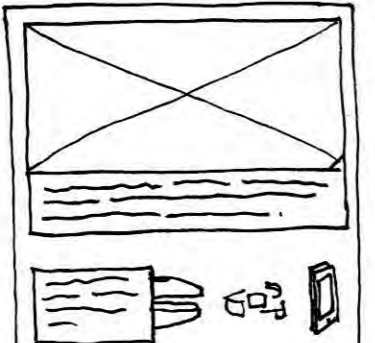
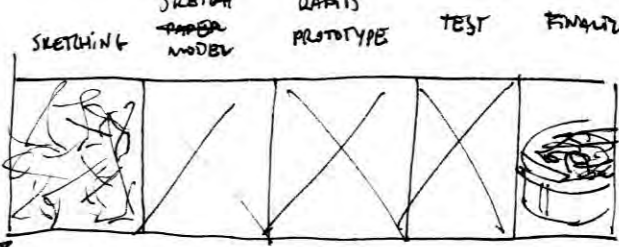
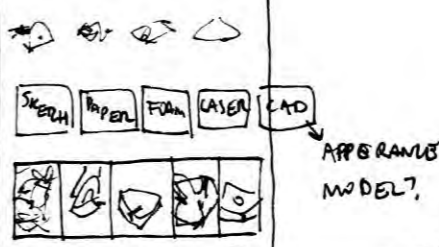
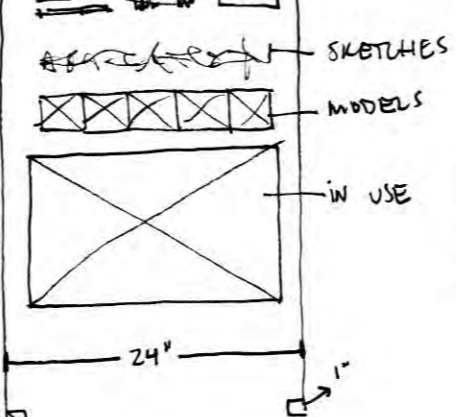
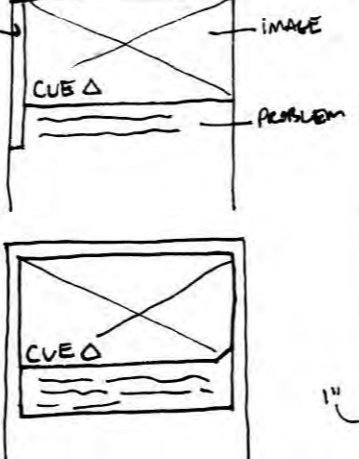
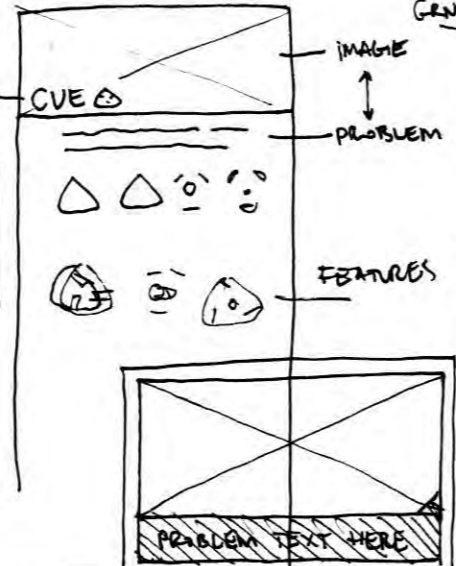
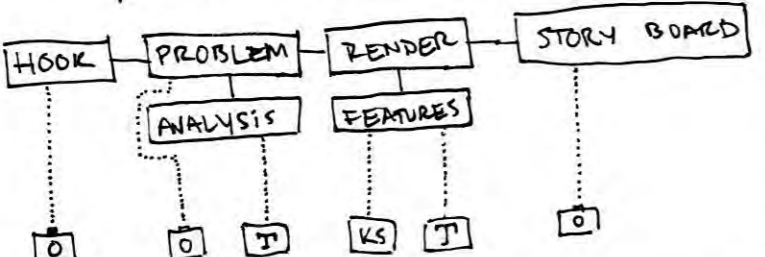
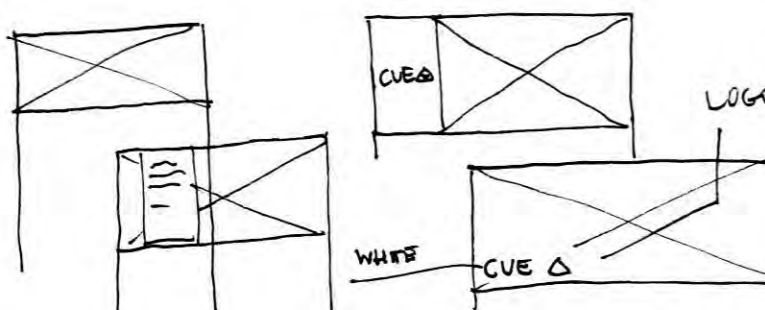

$$\begin{array}{r} 2.3 \\ 3 \overline{) 22.0} \\ \underline{-21} \\ 10 \\ \underline{-10} \\ 0 \end{array}$$

IND 360 24x72" POSTER COMPOSITION EXPLORATION

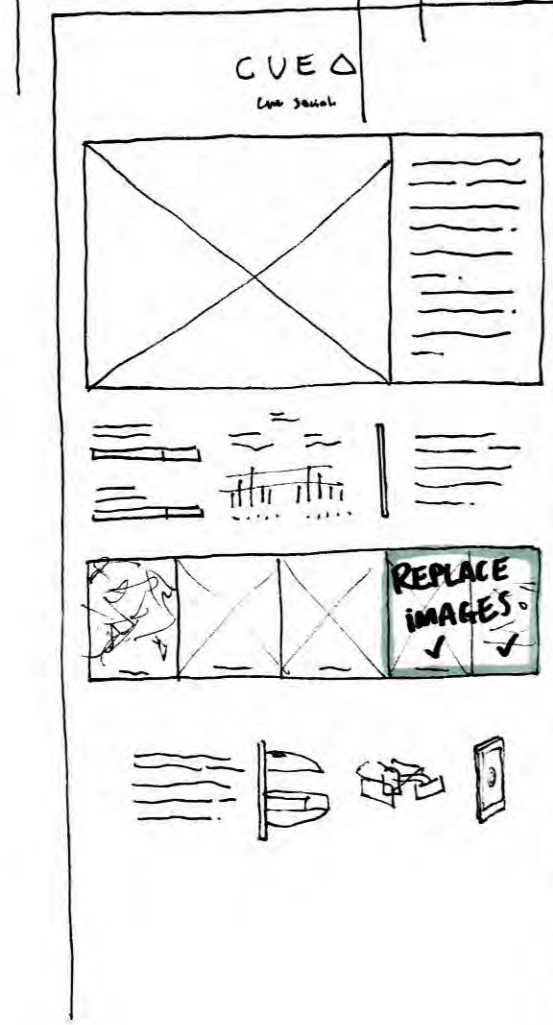

- NAME LOGO SLOGAN
- PROBLEM IMAGE
- PROBLEM STATEMENT
- SURVEY RECAP ANALYSIS
- PROBLEM IMAGES
SKETCHING, SKETCH MODELING, RAPID PROTOTYPING, TESTING, FINABLE.
- WIRELESS CHARGING INFO
- EXPLODED VIEW

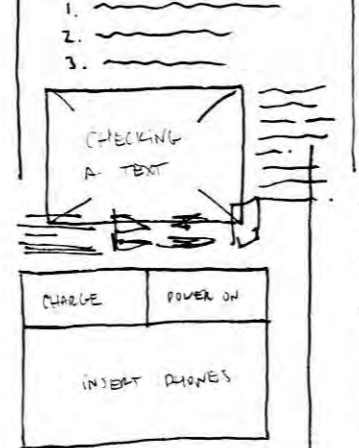
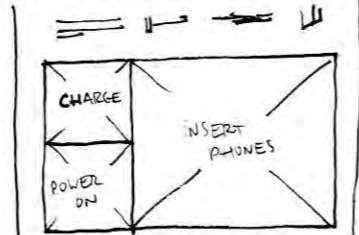

- CHARGE
- UNPLUG
- TAKE WITH YOU
- SET UP
- TURN ON
- INSERT PHONES
- LIGHTS TURN ON
- CHARGING BEGINS
- CHECK TEXT
- CHARGING STOPS

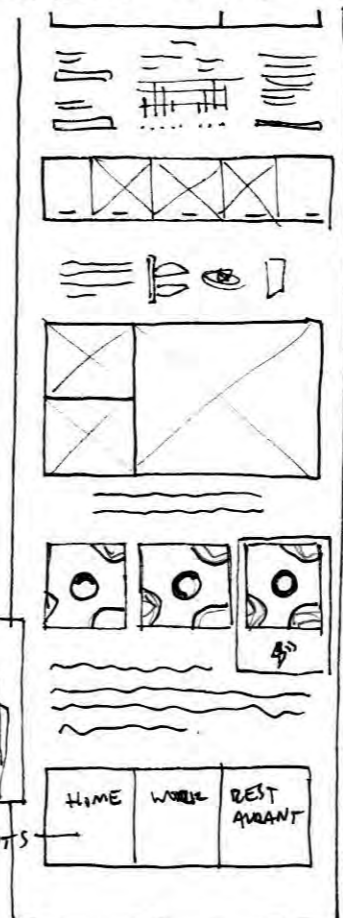
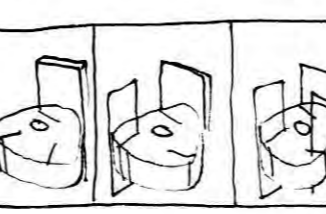
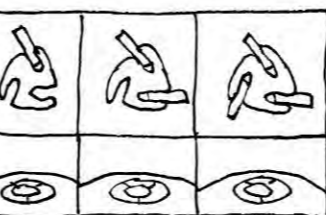
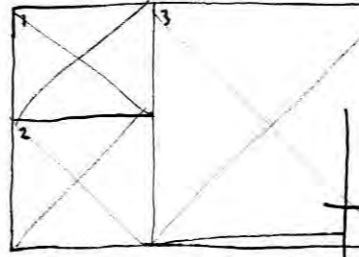

- PP increase title.
- left align consistent
- survey title > chapters
- analysis title
- QR CODE

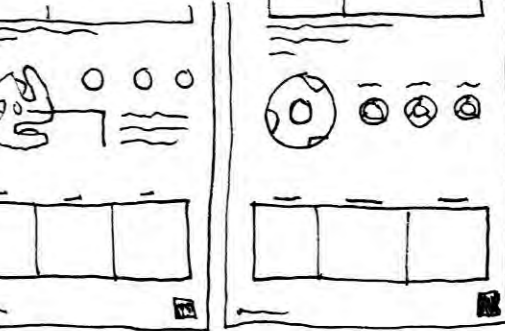
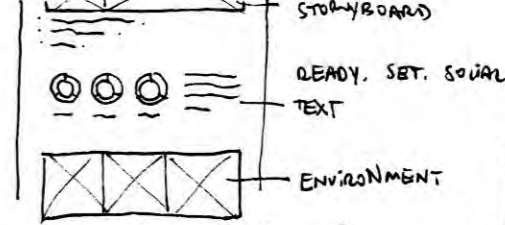

"align 1/3 rds, change problem image. fix font size. enlarge wireless charging phone image. EDIT collab. aspect"

Green

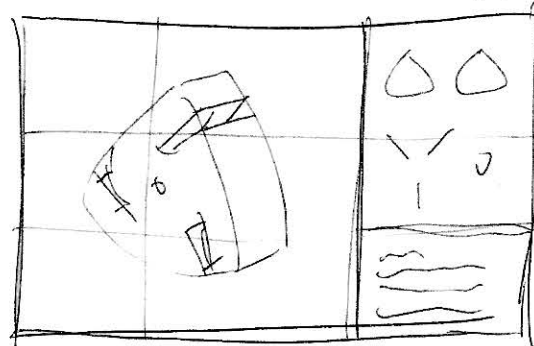
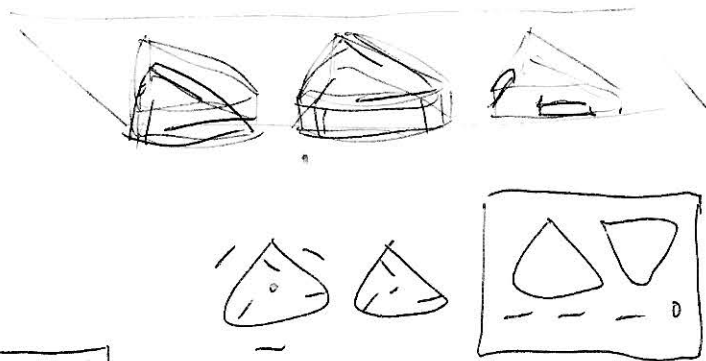
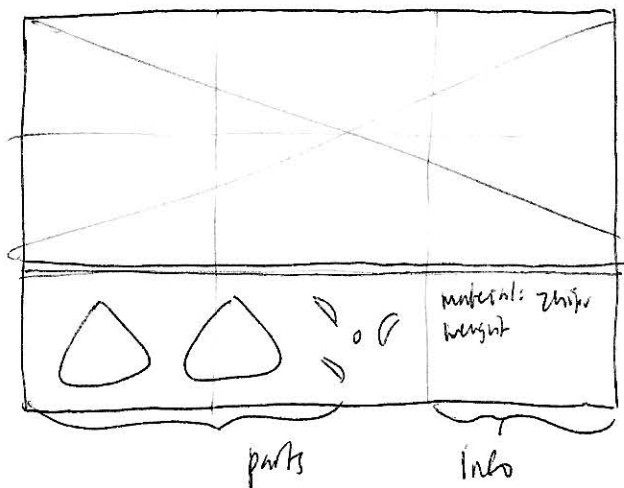
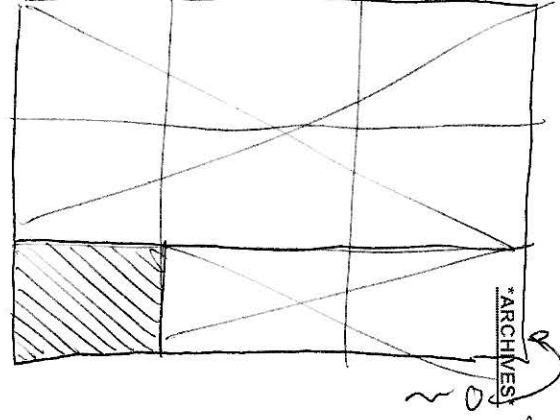
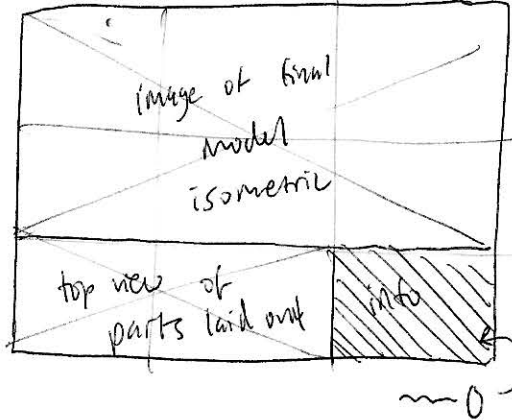
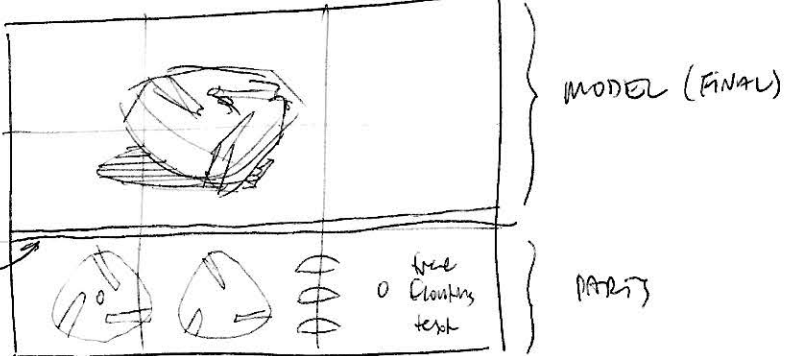

7.0 hours

12.00 hrs

19 hours

infill = high
2-site

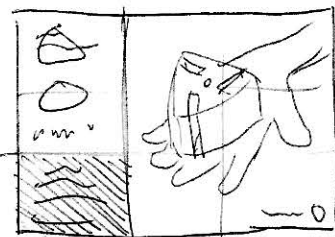

- INTRO
- PROBLEM
- SURVEY
- PROJECT ADDRESS
- SKETCH 1
- SKETCH 2
- WALL CUT
- CAD PROCESS
- FEATURES 1
- FEATURES 2
- APPEARANCE MODEL

$7.75 - 2.4 = 5.35$

$12 \div 5 = 2.4$

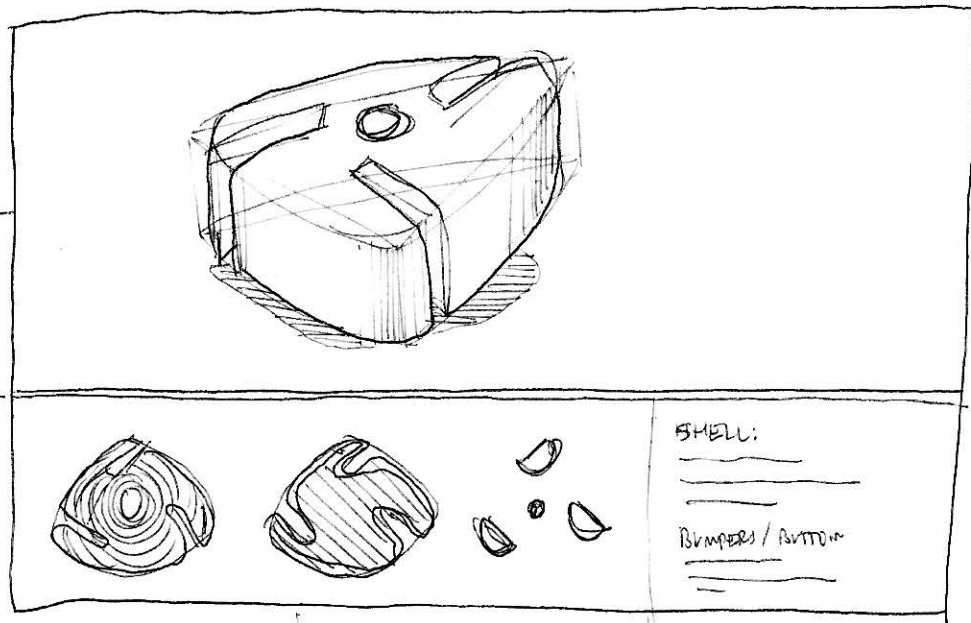
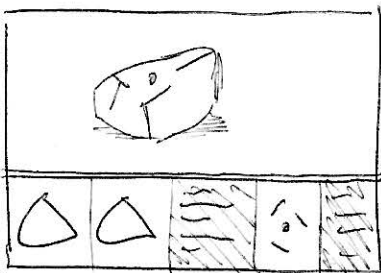

7.75"

12"

NICHOLAS W12